

PRIME MINISTER'S EMPLOYMENT GENERATION PROGRAMME (PMEGP)

1. The Scheme

Government of India has approved the introduction of a new credit linked subsidy programme called Prime Minister's Employment Generation Programme (PMEGP) by merging the two schemes that were in operation till 31.03.2008 namely Prime Minister's Rojgar Yojana (PMRY) and Rural Employment Generation Programme (REGP) for generation of employment opportunities through establishment of micro enterprises in rural as well as urban areas. PMEGP will be a central sector scheme to be administered by the Ministry of Micro, Small and Medium Enterprises (MoMSME). The Scheme will be implemented by Khadi and Village Industries Commission (KVIC), a statutory organization under the administrative control of the Ministry of MSME as the single nodal agency at the National level. At the State level, the Scheme will be implemented through State KVIC Directorates, State Khadi and Village Industries Boards (KVIBs) and District Industries Centres (DICs) and banks. The Government subsidy under the Scheme will be routed by KVIC through the identified Banks for eventual distribution to the beneficiaries / entrepreneurs in their Bank accounts. The Implementing Agencies, namely KVIC, KVIBs and DICs will associate reputed Non Government Organization (NGOs)/reputed autonomous institutions/Self Help Groups (SHGs)/ National Small Industries Corporation (NSIC) / Udyami Mitras empanelled under Rajiv Gandhi Udyami Mitra Yojana (RGUMY), Panchayati Raj institutions and other relevant bodies in the implementation of the Scheme, especially in the area of identification of beneficiaries, of area specific viable projects, and providing training in entrepreneurship development.

2. Objectives

- (i) To generate employment opportunities in rural as well as urban areas of the country through setting up of new self-employment ventures/projects/micro enterprises.
- (ii) To bring together widely dispersed traditional artisans/ rural and urban unemployed youth and give them self-employment opportunities to the extent possible, at their place.
- (iii) To provide continuous and sustainable employment to a large segment of traditional and prospective artisans and rural and urban unemployed youth in the country, so as to help arrest migration of rural youth to urban areas.
- (iv) To increase the wage earning capacity of artisans and contribute to increase in the growth rate of rural and urban employment.

3. Quantum and Nature of Financial Assistance

Levels of funding under PMEGP

Categories of beneficiaries under PMEGP	Beneficiary's contribution (of project cost)	Rate of Subsidy (of project cost)	
		Urban	Rural
Area (location of project/unit)			
General Category	10%	15%	25%
Special (including SC / ST / OBC /Minorities/Women, Ex-servicemen, Physically handicapped, NER, Hill and Border areas etc.	05%	25%	35%

- Note: (1) The maximum cost of the project/unit admissible under manufacturing sector is Rs. 25 lakh.
(2) The maximum cost of the project/unit admissible under business/service sector is Rs. 10 lakh.
(3) The balance amount of the total project cost will be provided by Banks as term loan

4. Eligibility Conditions of Beneficiaries

- (i) Any individual, above 18 years of age
- (ii) There will be no income ceiling for assistance for setting up projects under PMEGP.
- (iii) For setting up of project costing above Rs.10 lakh in the manufacturing sector and above Rs. 5 lakh in the business /service sector, the beneficiaries should possess at least VIII standard pass educational qualification.
- (iv) Assistance under the Scheme is available only for new projects sanctioned specifically under the PMEGP.
- (v) Self Help Groups (including those belonging to BPL provided that they have not availed benefits under any other Scheme) are also eligible for assistance under PMEGP.
- (vi) Institutions registered under Societies Registration Act,1860;
- (vii) Production Co-operative Societies, and
- (viii) Charitable Trusts.
- (ix) Existing Units (under PMRY, REGP or any other scheme of Government of India or State Government) and the units that have already availed Government Subsidy under any other scheme of Government of India or State Government are not eligible.

4.1 Other eligibility conditions

- (i) A certified copy of the caste/community certificate or relevant document issued by the competent authority in the case of other special categories, is required to be produced by the beneficiary to the concerned branch of the Banks along with the Margin Money (subsidy) Claim.
- (ii) A certified copy of the bye-laws of the institutions is required to be appended to the Margin Money (subsidy) Claim, wherever necessary.
- (iii) Project cost will include Capital Expenditure and one cycle of Working Capital. Projects without Capital Expenditure are not eligible for financing under the Scheme. Projects costing more than Rs.5 lakh, which do not require working capital, need clearance from the Regional Office or Controller of the Bank's Branch and the claims are required to be submitted with such certified copy of approval from Regional Office or Controller, as the case may be.
- (iv) Cost of the land should not be included in the Project cost. Cost of the ready built as well as long lease or rental Workshed/Workshop can be included in the project cost subject to restricting such cost of ready built as well as long lease or rental workshed/workshop to be included in the project cost calculated for a maximum period of 3 years only.
- (v) PMEGP is applicable to all new viable micro enterprises, including Village Industries projects except activities indicated in the negative list of Village Industries. Existing/old units are not eligible (Para 29 of the guidelines refers).

Note:

- (1) The Institutions/Production Co-operative Societies/Trusts specifically registered as such and SC/ ST/ OBC/ Women/ Physically Handicapped / Ex-Servicemen and Minority Institutions with necessary provisions in the bye-laws to that effect are eligible for Margin Money (subsidy) for the special categories. However, for Institutions /Production Cooperative Societies/Trusts not registered as belonging to special categories, will be eligible for Margin Money (Subsidy) for general category.
- (2) Only one person from one family is eligible for obtaining financial assistance for setting up of projects under PMEGP. The 'family' includes self and spouse.

5. Implementing Agencies

5.1 The Scheme will be implemented by Khadi and Village Industries Commission (KVIC), Mumbai, a statutory body created by the Khadi and Village Industries Commission Act, 1956, which will be the single nodal agency at the national level. At the State level, the scheme will be implemented through State Directorates of KVIC, State Khadi and Village Industries Boards (KVIBs) and District Industries Centres in rural areas. In urban areas, the Scheme will be implemented by the State District Industries Centres (DICs) only. KVIC will coordinate with State KVIBs/State DICs and monitor performance in rural and urban areas. KVIC and DICs will also involve NSIC, Udyami Mitras empanelled under

Rajiv Gandhi Udyami Mitra Yojana (RGUMY), Panchayati Raj Institutions and other NGOs of repute in identification of beneficiaries under PMEGP.

5.2 Other Agencies

The details of other agencies to be associated by nodal agencies in the implementation of PMEGP are as under:

- i) Field Offices of KVIC and its State offices
- ii) State KVI Boards
- iii) District Industries Centre (DIC) of all State Governments/Union Territories Administrations reporting to respective Commissioners /Secretaries (Industries).
- iv) Banks/Financial Institutions.
- v) KVI Federation
- vi) Department of Women and Child Development (DWCD), Nehru Yuva Kendra Sangathan (NYKS), The Army Wives Welfare Association of India (AWWA) and Panchayati Raj Institutions
- vii) NGOs having at least five years experience and expertise in Project Consultancy in Small Agro & Rural Industrial Promotion and Technical Consultancy Services, Rural Development, Social Welfare having requisite infrastructure and manpower and capable of reaching Village and Taluk level in the State or Districts. NGOs should have been funded by State or National Level Government Agency for any of its programmes in the preceding 3 years period.
- viii) Professional Institutions/Technical Colleges recognized by Government/University and University Grants Commission (UGC)/ All India Council for Technical Education (AICTE) having department for vocational guidance or technical courses providing skill based training like ITI, Rural Polytechnic, Food Processing Training Institute, etc.
- ix) Certified KVI institutions aided by KVIC / KVIB provided these are in category A+, A or B and are having required infrastructure, manpower and expertise for the role.
- x) Departmental and Non-Departmental Training Centres of KVIC / KVIBs.
- xi) Micro, Small and Medium Enterprises Development Institutes (MSME-DIs), MSME Tool Rooms and Technical Development Centres, under the administrative control of Office of Development Commissioner, MSME.
- xii) National Small Industries Corporation's (NSIC) offices, Technical Centres, Training Centres, Incubators and Training cum Incubation Centres (TICs) set up in PPP Mode.

- xiii) National level Entrepreneurship Development Institutes like National Institute for Entrepreneurship and Small Business Development (NIESBUD), National Institute for Micro, Small and Medium Enterprises (NIMSME) and Indian Institute of Entrepreneurship (IIE), Guwahati under the administrative control of Ministry of MSME, their branches and the Entrepreneurship Development Centres (EDCs) set up by their Partner Institutions (PIs).
- xiv) Udyami Mitras empanelled under Rajiv Gandhi Udhya Mitra Yojana of Ministry of MSME.
- xv) PMEGP Federation, whenever formed.

6. Financial Institutions

- (i) 27 Public Sector Banks.
- (ii) All Regional Rural Banks.
- (iii) Co-operative Banks approved by State Level Task Force Committee headed by Principal Secretary (Industries)/Commissioner (Industries)
- (iv) Private Sector Scheduled Commercial Banks approved by State Level Task Force Committee headed by Principal Secretary (Industries)/Commissioner (Industries).
- (v) Small Industries Development Bank of India (SIDBI).

7. Identification of beneficiaries:

The identification of beneficiaries will be done at the district level by a Task Force consisting of representatives from KVIC/State KVIB and State DICs and Banks. The Task force would be headed by the District Magistrate / Deputy Commissioner / Collector concerned. The Bankers should be involved right from the beginning to ensure that bunching of applications is avoided. However, the applicants, who have already undergone training of at least 2 weeks under Entrepreneurship Development Programme (EDP) / Skill Development Programme (SDP) / Entrepreneurship cum Skill Development Programme (ESDP) or Vocational Training (VT) will be allowed to submit applications directly to Banks. However, the Banks will refer the application to the Task Force for its consideration. Exaggeration in the cost of the project with a view only to availing higher amount of subsidy should not be allowed. KVIC will devise a score card in consultation with SBI and RBI, and forward it to the District Level Task Force and other State/District functionaries. This score board will form the basis for the selection of beneficiaries. This score card will also be displayed on the websites of KVIC and Ministry. The selection process should be through a transparent, objective and fair process and Panchayati Raj Institutions should be involved in the process of selection (Para 11 (i)(b) of the guidelines refers).

8. Bank Finance

8.1 The Bank will sanction 90% of the project cost in case of General Category of beneficiary/institution and 95% in case of special category of the beneficiary/institution, and disburse full amount suitably for setting up of the project.

8.2 Bank will finance Capital Expenditure in the form of Term Loan and Working Capital in the form of cash credit. Project can also be financed by the Bank in the form of Composite Loan consisting of Capital Expenditure and Working Capital. The amount of Bank Credit will be ranging between 60-75% of the total project cost after deducting 15-35% of margin money (subsidy) and owner's contribution of 10% from beneficiaries belonging to general category and 5% from beneficiaries belonging to special categories. This scheme will thus require enhanced allocations and sanction of loans from participating banks. This is expected to be achieved as Reserve Bank of India (RBI) has already issued guidelines to the Public Sector Banks to ensure 20 % year to year growth in credit to MSME Sector. SIDBI is also strengthening its credit operations to micro enterprises so as to cover 50 lakh additional beneficiaries over five years beginning 2006-07, and is recognized as a participating financial institution under PMEGP besides other scheduled/ Commercial Banks.

8.3 Though Banks will claim Margin Money (subsidy) on the basis of projections of Capital Expenditure in the project report and sanction thereof, Margin Money (subsidy) on the actual availment of Capital Expenditure only will be retained and excess, if any, will be refunded to KVIC, immediately after the project is ready for commencement of production.

8.4 Working Capital component should be utilized in such a way that at one point of stage it touches 100% limit of Cash Credit within three years of lock in period of Margin Money and not less than 75% utilization of the sanctioned limit. If it does not touch aforesaid limit, proportionate amount of the Margin Money (subsidy) is to be recovered by the Bank/Financial Institution and refunded to the KVIC at the end of the third year.

8.5 Rate of interest and repayment schedule

Normal rate of interest shall be charged. Repayment schedule may range between 3 to 7 years after an initial moratorium as may be prescribed by the concerned bank/financial institution. It has been observed that banks have been routinely insisting on credit guarantee coverage irrespective of the merits of the proposal. This approach needs to be discouraged.

RBI will issue necessary guidelines to the Banks to accord priority in sanctioning projects under PMEGP. RBI will also issue suitable guidelines as to which RRBs and other banks will be excluded from implementing the Scheme.

9. Industry

Any Industry including Coir based projects (except those mentioned in the negative list) which produces goods or renders any service with or without the use of power and in which the fixed capital investment per head of a full time artisan or worker i.e. Capital Expenditure on workshop/workshed, machinery and furniture divided by full time employment created by the project does not exceed Rs. 1 lakh in plain areas and Rs.1.50 lakh in hilly areas.

10. Rural Area

- (i) Any area classified as Village as per the revenue record of the State/Union Territory, irrespective of population.
- (ii) It will also include any area even if classified as town, provided its population does not exceed 20,000 persons.

11. Modalities of the operation of the Scheme

- (i) Project proposals will be invited from potential beneficiaries at district level through press, advertisement, radio and other multi-media by KVIC, KVIBs and DICs at periodical intervals depending on the target allotted to that particular district. The scheme will also be advertised /publicized through the Panchayati Raj Institutions which will also assist in identification of beneficiaries.
- (a) Sponsoring of project by any agency is not mandatory. The beneficiary can directly approach Bank/Financial Institution along with his/her project proposal or it can be sponsored by KVIC/ KVIBs / DIC/Panchayat Karyalayas etc. However, the applications received directly by the Banks will be referred to the Task Force for its consideration.
- (b) A Task Force, consisting of the following members, will be set up to scrutinize the applications received by it.

Dist Magistrate/Deputy Commissioner/Collector	- Chairman
Lead Bank Manager	- Member
Representative of KVIC/KVIB/DIC	- Member
Representative of NYKS/SC/ST Corporation	- Special Invitee
Representative of MSME-DI, ITI/Polytechnic	- Special Invitee
Representatives from Panchayats	- 3 members
(To be nominated by Chairman/District Magistrate/Deputy Commissioner/ Collector by rotation)	
General Manager, DIC or Rep.of KVIC or Rep.of KVIB	-Member Convenor

- (c) The Task Force will scrutinize the applications and based on the experience, technical qualification, skill, viability of the project etc., the task force will shortlist the applications and call for an interview of the applicants separately for rural and urban areas to assess their knowledge about the proposed project, aptitude, interest, skill and entrepreneurship abilities, market available, sincerity to repay and make the proposed project success. The selected candidates will be provided project formulation guidance and orientation by KVIC, KVIBs and DICs who will also assist and guide them in project formulation and submission to the concerned Bank in the area. The applicants may also approach any of the other agencies listed in para 5.2 of these guidelines for assistance in this regard.
 - (d) KVIC will identify the Nodal Banks at State level in consultation with State Governments and will forward the list to all the implementing agencies.
- (ii) The release of funds to the implementing agencies will be in the following manner:-
- (a) Government will provide funds under PMEGP to the nodal implementing agency, i.e. KVIC which will in turn, (within a period of 15 days of receipt of the money from the Government), place the margin money (subsidy) funds with the implementing Banks at the State level in their respective accounts in accordance with the targets allocated to each implementing agency. CEO, KVIC will convey the margin money (subsidy) targets allotted to each State to the Principal Secretaries/Secretaries (Industries)/ Commissioners (Industries) simultaneously. The target among the Districts in the State will be assigned by the State Level Bankers Coordination Committee. SLBCC will ensure that targets are evenly distributed within each district. The State-wise targets in respect of KVIC/KVIBs will be made available by KVIC to SLBCC where overall allocation of district-wise targets will be decided. Any modification of the targets for which KVIC is directly responsible will be permitted only with the concurrence of the Ministry.
 - (b) KVIC will place the margin money (subsidy) amount with the Banks involved in the implementation of the scheme in accordance with the targets allocated to the implementing Banks in the State/ District. DICs, in close coordination with Banks, will ensure that at least 50 % of the total margin money (subsidy) allocated to them will be utilized in setting up of projects in rural areas.

- (c) KVIC being the single Nodal Agency at the National level, will coordinate with the identified implementing agencies, i.e., KVIBs, DICs and others. KVIC will carry out most of the important tasks envisaged in the forward and backward linkages, including e-tracking, web management, publicity, physical verification of units, organizing EDP training programmes, awareness camps, workshops and exhibitions and therefore will require to utilize major share of the allocation under forward and backward linkages. However, KVIC will ensure that it will reserve and allocate at least 25 % of the total allocation under Forward and Backward linkages, under the Scheme to DICs of different participating States appropriately taking into account the demand and extent of implementation. This money will be released to DICs, only after obtaining an undertaking from the State Government that the funds already provided under the erstwhile PMRY Scheme's Training and Pre motivational campaigns have been fully utilized by the DICs. Any unspent balance available under the training and contingencies of erstwhile PMRY Scheme will be utilized for training and relevant expenditure under PMEGP. DICs will submit monthly utilization report to KVIC in this regard.
- (d) The Task Force, under the chairmanship of District Magistrate/Deputy Commissioner / Collector will hold **quarterly** meeting with the Banks at district level to review the status of the project proposals. Wherever the projects are rejected, shortcomings/reasons will be furnished by the concerned Banks to the implementing agencies concerned and the applicants concerned will be requested by KVIC/KVIBs / DICs to provide additional information/documents if required and concerned representatives of KVIC, KVIBs and DICs, will provide assistance to the applicants in this process. Since the Bank's representative will also be a member of the Task Force, it needs to be ensured that maximum number of projects, cleared by the Task Force, is sanctioned by the Banks. Chairman of the District Task Force will review the performance of Banks and the loan repayment / recovery status in the quarterly review meetings.
- (e) Banks will take their own credit decision on the basis of viability of each project. No collateral security will be insisted upon by Banks in line with the guidelines of RBI for projects involving loan upto Rs. 5 lakh in respect of the projects cleared by the Task Force. However, they will appraise projects both technically and economically after ensuring that each project fulfills *inter alia* the criteria of
- (i) Industry
 - (ii) Per Capita Investment
 - (iii) Own Contribution
 - (iv) Rural Areas (projects sponsored by KVIC/ KVIBs/DICs) and
 - (v) Negative List (Para 29 of the guidelines refers)

It is essential that the applications cleared by the District Task Force also fulfill these requirements at that stage itself so as to avoid delays in approval of loans in Banks.

- (f) Once the project proposals are received by KVIC, KVIBs, DICs or Banks, the details of such proposals are to be fed in the web based application tracking system with a unique registration number for each beneficiary at the District level by the State Offices of KVIC/State KVIBs/State DICs to enable the entrepreneurs to track their application status at any point of time. Till such time the e-tracking system becomes fully operational (for which detailed guidelines will be issued by KVIC separately to all concerned) disaggregated data in respect of progress of each application, assistance availed by beneficiaries belonging to special categories (category wise), employment details, etc., will be maintained by KVIC/KVIBs/DICs and the data will be reconciled every month with Director (PMEGP) in KVIC. The status of such reconciliation will be reviewed by the District Magistrate / Deputy Commissioner / Collector, in the Task Force meetings and by CEO, KVIC in the review meetings at KVIC. Separate colour code will be given to application form as well as applications/claim forms of Margin Money (subsidy) through KVIC/KVIBs/DICs, so as to help the beneficiaries and the processing/sanctioning functionaries to identify and monitor the progress of implementation.
- (g) Once the project is sanctioned and **before the first installment of the Bank Finance is released to the beneficiary, Bank will inform the State/Regional Office of the KVIC/KVIBs/State DICs, as the case may be, for arranging EDP training (Para 12(i) of the guidelines refers) to the beneficiary, if he/she has not already undergone such training.** If he/she has already undergone such training of at least 2 weeks duration, either with the training centre of KVIC/KVIB /State DICs or the institutions recognized by or under the administrative control of Ministry of MSME or at any other training centre of repute, such beneficiary need not undergo further EDP training.
- (h) First installment of the loan will be released to the beneficiary only after completion of EDP training of at least 2 weeks (Para 12 of the guidelines refers) specially designed for the purpose, which will be organized by KVIC / KVIBs / DICs or the institutions recognized by or under the administrative control of Ministry of MSME or at any other training centre of repute. Those who have already undergone training from the recognized institutions need not undergo further EDP training.

- (i) After the successful completion of EDP training arranged by the KVIC/KVIBs/State DICs, **the beneficiary will deposit with the bank, the owner's contribution.** Thereafter, the bank will release first installment of the Bank Finance to the beneficiary.
- (j) Projects sanctioned will be declared ineligible for Margin Money (subsidy) assistance if the EDP training is not completed.
- (k) After the release of Bank finance either partly or fully, Bank will submit Margin Money (subsidy) claim in the prescribed format to the designated Nodal Branch of the State/Region where KVIC has placed lump sum deposit of Margin Money (subsidy) in advance in the Savings Bank Account in the name of KVIC, for release of Margin Money (subsidy). In the case of projects financed by the branches of the Regional Rural Banks, the financing branches of the RRBs will have to submit the Margin Money (subsidy) Claim to their Head Office, which, in turn, will submit the consolidated claims to the designated Nodal Branch of their sponsoring Bank. In the case of projects financed by SIDBI, the guidelines issued by SIDBI for release of loan/margin money (subsidy) will be followed. **Though the margin money (subsidy) will be released by the designated Nodal Branch of the Bank, KVIC/KVIB State DIC is the final authority to either accept the project/claim or reject, based on the parameters of the Scheme.** Detailed grounds for rejections shall be maintained by KVIC/KVIBs/DICs. A separate system of acknowledging grievances or complaints will be instituted by KVIC/KVIBs and DICs and a monthly report with the details of grievances / complaints received and the status / action taken for their redressal shall be furnished to CEO, KVIC by KVIBs and DICs. A consolidated report will be forwarded to the Ministry of MSME every quarter by CEO, KVIC.
- (l) Once the Margin Money (subsidy) is released in favour of the loanee, it should be kept in the Term Deposit Receipt of **three years** at branch level in the name of the beneficiary/Institution. **No interest will be paid on the TDR and no interest will be charged on loan to the corresponding amount of TDR.**
- (m) Since "Margin Money" (subsidy) is to be provided in the form of subsidy (Grant), it will be credited to the Borrowers loan account after **three years** from the date of first disbursement to the borrower/institution, by the Bank.
- (n) In case the Bank's advance goes "bad" before the **three year** period, due to reasons, beyond the control of the beneficiary, the Margin Money (subsidy) will be adjusted by the Bank to liquidate the loan liability of the borrower either in part or full.

- (o) In case any recovery is effected subsequently by the Bank from any source whatsoever, such recovery will be utilized by the Bank for liquidating their outstanding dues first. Any surplus will be remitted to KVIC.
- (p) **Margin Money (subsidy) will be 'one time assistance'**, from Government. For any enhancement of credit limit or for expansion/modernization of the project, margin money (subsidy) assistance is **not** available.
- (q) Margin Money (subsidy) assistance is available only for **new** projects sanctioned specifically under the PMEGP. Existing units are **not** eligible under the Scheme.
- (r) Projects financed jointly i.e. financed from two different sources (Banks / Financial institutions), are **not** eligible for Margin Money (subsidy) assistance.
- (s) Bank has to obtain an undertaking from the beneficiary before the release of Bank Finance that, in the event of objection (recorded and communicated in writing) by KVIC /KVIB/State DIC, the beneficiary will refund the Margin Money (subsidy) kept in the TDR or released to him after **three years** period.
- (t) Banks / KVIC / KVIBs / DICs have to ensure that each beneficiary prominently displays the following sign-board at the main entrance of his project site:-

.....(Unit Name)

Financed By (Bank), District Name
Under
Prime Minister's Employment Generation
Programme (PMEGP)

Ministry of Micro, Small and Medium Enterprises

- (u) Margin Money (subsidy) Claim will be submitted by the Financing Branch of the Bank to the designated Nodal Branch at the earliest possible time.

12. Entrepreneurship Development Programme (EDP)

12.1 The objective of EDP is to provide orientation and awareness pertaining to various managerial and operational functions like finance, production, marketing, enterprise management, banking formalities, bookkeeping, etc. The duration for EDP under REGP was only 3 days, whereas, under PMRY it was 10 days. During various meetings, discussions and recommendations of Department Related Parliamentary Standing Committee for Industry (DRPSCI) it was felt that 3 days were not adequate for providing this inputs effectively and, hence **two to three weeks** period has been provided under PMEGP which will include interaction with successful rural entrepreneur, banks as well as orientation

through field visits. The EDP will be conducted through KVIC, KVIB Training Centers as well as Accredited Training Centers run by Central Government, NSIC, the three national level Entrepreneurship Development Institutes (EDIs), i.e., NIESBUD, NIMSME and IIE, and their partner institutions under the administrative control of Ministry of MSME, State Governments, Banks, Rural Development and Self Employment Training Institutes (RUDSETI) reputed NGOs, and other organizations / institutions, identified by the Government from time to time. EDP will be mandatory for all the PMEGP beneficiaries. However, the beneficiaries who have undergone EDP earlier of duration not less than two weeks through KVIC/KVIB or reputed training centers will be exempted from undergoing fresh EDP. The training centres / institutes will be identified by KVIC and extensive publicity will be provided about the training centres / institutes, content of courses available, duration, etc. by circulating the same to all the Implementing Agencies.

12.2. Budget for EDP Charges to the Training Centers

An amount of Rs. 2500/- to Rs.4000/- per trainee for a period of two to three weeks towards course material, honorarium to guest speakers, lodging, boarding expenses, etc. is admissible under the Scheme. KVIC will reimburse the expenditure to the training centres / institutes chosen for the purpose, in accordance with the procedures to be separately devised by it and circulated to KVIBs and DICs.

13. Physical verification of PMEGP Units

100% physical verification of the actual establishment and working status of each of the units, set up under PMEGP, including those set up through KVIBs and DICs, will be done by KVIC, through the agencies of State Government and/or, if necessary by outsourcing the work to professional institutes having expertise in this area, following the prescribed procedures as per General Financial Rules (GFR) of Government of India. Banks, DICs and KVIBs will coordinate and assist KVIC in ensuring 100 % physical verification. A suitable proforma will be designed by KVIC for such physical verification of units. Quarterly reports, in the prescribed format will be submitted by KVIC to the Ministry of MSME.

14. Awareness Camps

14.1 KVIC and State DICs will organize awareness camps, in close coordination with each other and KVIBs, throughout the country to popularize PMEGP and to educate potential beneficiaries in rural, semi rural and urban areas about the Scheme. The awareness camps will involve participation from the unemployed men and women with special focus on special category, i.e., SC, ST, OBC, Physically challenged, Ex-servicemen, Minorities, Women, etc. The requisite information/details in this regard will be obtained by KVIC/KVIBs/DICs from State level organizations like SC/ST Corporations, AWWA, NYKS, reputed NGOs and Employment exchanges. There will be two camps permissible for a

district, one by KVIC in coordination with concerned KVIB and another by DIC. KVIC and DIC should preferably consider organizing these camps jointly for a specific district. A Committee consisting of Lead Bank, KVIC/KVIB/DIC and Principal, Multi Disciplinary Training Centres (MDTC) of KVIC will shortlist the beneficiaries and send them for training as well as RICS for project formulation and to Bank for project sanction. The amount specified can be spent on publicity, arrangement and other necessary expenses for organizing such camps, which will be communicated by KVIC in their guidelines separately.

14.2 Mandatory activities to be undertaken in the awareness camps:

- (i) Publicity through banners, posters, hoardings and press advertisements in local newspapers.
- (ii) Presentation on the scheme by KVIC/KVIB/DIC officials.
- (iii) Presentation by Lead Bank of the area.
- (iv) Presentation by successful PMEGP/REGP Entrepreneurs.
- (v) Distribution of sanction letters to PMEGP entrepreneurs who have been sanctioned the project by Bank.
- (vi) Press conference
- (vii) Collection of data (in the prescribed format) from the potential beneficiaries, which will include information like profile of beneficiaries, skills possessed, background and qualifications, experience, project interested in, etc. For ascertaining the training (as described in para 12 of the guidelines) a committee consisting of representatives of Lead Bank, KVIC, KVIB, DIC and Principal, MDTC will shortlist the beneficiaries and send them for orientation and training. They will also be sent to RICS and Banks for project formulation and project sanction, respectively.
- viii) A **Shelf of Projects** for consideration under PMEGP, prepared by KVIC has already been circulated by KVIC/Ministry to some of the prominent State Industries Secretaries and Banks including State Bank of India, Central Bank of India, Canara Bank, Allahabad Bank and Union Bank of India. For any further inclusion of projects in the shelf already prepared, KVIBs and DICs shall forward the details of such projects to KVIC. KVIC will in turn, expand the Shelf of Projects, in due course, in consultation with Banks, KVIBs and DICs, by utilizing the provisions in 'Training and Orientation' under forward and backward linkages.

(ix) Marketing Support

- (a) Marketing support for the products, produced by the units under PMEGP may be provided through KVIC's Marketing Sales outlets, as far as possible. KVIC will reserve the right to provide such a support based on quality, pricing and other parameters to be separately circulated by KVIC to KVIBs/DICs.
- (b) Besides the above, Exhibitions, Workshops at District/State Zonal/National and International levels, Buyer-Seller Meets, etc., will be arranged for the benefit of PMEGP beneficiaries by KVIC.

15. Workshops

a) Objectives

- (i) To brief potential beneficiaries about benefits under the PMEGP Scheme and other KVIC Schemes like PRODIP, SFURTI, etc.
- (ii) To create a Data Bank of PMEGP units regarding products produced, services /business activity details, production, supply capacity, present marketing set up employment and project cost, etc.
- (iii) To interact with PMEGP entrepreneurs to obtain feed back about the units, their problems, support required, success stories etc.
- (iv) To involve experts in marketing and export to support PMEGP units in these areas.

Note: (i). It should be ensured that a minimum number of 200 prospective entrepreneurs participate in the Workshop.
(ii) One State level Workshop for KVIC and one for DIC are permissible.
(iii) KVIC and DIC may consider organizing these Workshops jointly in a specific State
(iv) One representative of KVIC, KVIB and DIC will participate in each Workshop.

b) The State Level Workshop will include the following activities:

- (i) Presentation of PMEGP Scenario of the State.
- (ii) Presentation of views of Banks on PMEGP by senior officials of lead Bank in the State.
- (iii) Sharing of experience and success stories by PMEGP/REGP entrepreneurs, providing special emphasis to entrepreneurs belonging to special categories.

- (iv) Briefing about support Schemes of KVIC like Product Development, Design Intervention and Packaging (PRODIP), Rural Industrial Service Centres (RISC), Scheme of Fund for Regeneration of Traditional Industries (SFURTI), Micro and Small Enterprises Cluster Development Programme (MSECDP), Credit Linked Capital Subsidy Scheme for Technology Upgradation (CLCSS), Credit Guarantee Fund Trust for Micro and Small Enterprises (CGTSME), etc.
 - (v) Briefing about support schemes related to cluster and marketing by NABARD and SIDBI.
 - (vi) Utilizing the services of NYKS, MWCD, AWWA for involving the rural youth, weaker sections, women, minorities, ex-servicemen, physically challenged, war widows in PMEGP.
 - (vii) Presentation on Domestic and Export Market Potential available, by Marketing experts.
 - (viii) Open house discussion with PMEGP entrepreneurs on implementation issues, constraints encountered, further supports required, etc., and arriving at possible solutions.
 - (ix) Data collection of PMEGP entrepreneurs in the prescribed format.
 - (x) Arranging the exhibition cum sale of PMEGP products.
 - (xi) Formation of PMEGP Federation.
 - (xii) Press conference.
- (c) KVIC will be co ordinating these workshops and will get the annual calendar of workshops approved by the Ministry, in advance.

16. Exhibitions

PMEGP Exhibitions will be organized by KVIC at National, Zonal, State and District Levels and special exhibitions for North Eastern Zone in co ordination with KVIBs and DICs, to promote products produced by PMEGP units. KVIC will get the annual calendar of exhibitions to be conducted at various parts of the country, approved by the Ministry in advance. Separate pavilions will be provided for display of products produced by units set up through KVIBs/DICs. Separate logos and nomenclature for rural entrepreneurs and urban entrepreneurs will be worked out by KVIC/KVIBs/DICs. For example, for rural PMEGP exhibitions nomenclatures like GRAMEXPO, GRAMUSTAV, GRAM MELA, etc., may be used. KVIC, in coordination with KVIBs and DICs will be organizing one district level exhibition (per district), one State level exhibition and one Zonal level exhibition, annually.

17. Participation in International Exhibitions

Participation by PMEGP units is envisaged in International Exhibitions like India International Trade Fair (IITF), etc., for developing their export market. KVIC will organize participation in the international exhibitions in coordination with KVIBs and DICs and will seek the list of willing units from KVIBs and DICs. KVIC will ensure that the units desirous of participating in the fair, set up through KVIBs and DICs are considered judiciously on the basis of merit, variety and quality of the products. A maximum amount of Rs. 20 lakh will be provided to meet expenditure on rental charges for pavilion, fabrication of stalls and towards display, demonstration etc. KVIC may meet the rest of the expenditure out of its regular marketing budget provisions.

18. Bankers Review Meetings

PMEGP is a bank driven scheme and the final sanction of project and release of loan is done at the level of concerned Bank. It is therefore imperative that KVIC, KVIBs and DICs interact regularly with the higher officials of Bankers at District/ State/National level to ensure that the bottle necks, if any, in implementation, are resolved, outcomes are effectively achieved and targets are met. Bankers Review Meeting at following levels shall be organized as below:

- (i) **Lead District Managers Meet (LDM):** This will be organized by State Office and Divisional Office of KVIC jointly with KVIB and DIC. The focus of the meeting will be to inform and educate the bank officials at LDM level about PMEGP and regularly monitor and review the implementation of the scheme. The meeting will be held on quarterly basis.
- (ii) **Zonal review meeting:** To review and monitor the PMEGP scheme, zonal review will be conducted quarterly by KVIC in 6 zones where representatives of KVIC, KVIB and DIC will participate in the review. Concerned Bank officers will also be invited.
- (iii) **Top level Bankers Meeting:** KVIC will organize the Top Level Bankers meeting half yearly (in June and December) so that proper monitoring can be done at the beginning and towards the end of the financial year. CMDs/Senior Executives of nationalized Banks, representatives from Ministry of MSME, State DICs and KVIBs will participate in the National level Bankers meeting which will be chaired by CEO, KVIC. All the States/UTs will be invited in two groups and KVIC will ensure that around half of the States/UTs' representatives (of KVIBs and DICs) participate in each of these half yearly review meetings. The meeting will focus on reviewing the targets and will examine the issues related to policy decisions relating to banks for the implementation of PMEGP.

19. Orientation and Training under PMEGP

The staff and officers of KVIC, KVIB, DIC and concerned agencies have to be sensitized on the operational modalities of PMEGP which can be imparted in the 'one day training workshops' to be conducted throughout the country at State / District levels by KVIC (in coordination with KVIBs) and DICs. 40 such programmes per year will be organized by KVIC and DICs (each). KVIC and DICs may organize such training workshops jointly, wherever feasible, on the basis of guidelines to be issued by KVIC separately, for this purpose.

20. TA/DA of Staff and Officers

The officers of KVIC, KVIBs and DICs will carry out relevant field visits and monitoring activities of PMEGP. A provision of Rs. 1 crore per year is proposed towards TA/DA of staff and officers for monitoring and reviewing PMEGP, which includes administrative expenses like stationery, documentation, contingencies, etc., and around 40% of this amount can be earmarked for DICs. KVIC will issue separate guidelines incorporating the detailed modalities of certification of the expenditure, laying down the norms for such field visits so as to optimally utilize the assistance and ensure economy in expenditure.

21. Publicity and promotional activities

21.1 PMEGP should be popularized through aggressive publicity campaigns including posters, banners, hoardings, radio jingles, television messages, advertisements in local papers, press conferences, also involving VVIPs and distinguished guests in major events of PMEGP.

21.2 Release of advertisement/publicity for PMEGP.

Advertisement will be issued /published in English, Hindi and local language newspapers. For District level events, quarter page advertisement will be released and for State level events, half a page advertisement will be released.

Keeping in view the significance of publicity and promotional activities required to be undertaken for PMEGP, an amount of Rs.16 Crore will be allocated during the four years period. 25 % of funds will be earmarked by KVIC to DICs for release of advertisement/ publicity of the Scheme, in accordance with the guidelines framed by KVIC while ensuring maximum coordination and synergy of efforts with KVIBs and DICs.

22. MIS Package, Application Tracking System, E-Portal and other supporting packages

22.1 E-governance is a vital requirement for effective monitoring and reviewing of the scheme. In addition, data base of existing REGP beneficiaries as well as PMRY have also to be documented. A separate PMEGP website will be constructed by KVIC, including all the relevant

linkages with Ministry of MSME, State KVIBs, DICs, NIC and Banks, providing all the necessary information. Application tracking system will also be introduced by KVIC in coordination with KVIBs / DICs for PMEGP beneficiaries. In addition Rural Industrial Consultancy Services (RICS)'s software package for project preparation of KVIC will be extended to all training centers in the country for assisting potential beneficiaries to prepare project under PMEGP. A separate provision is available under forward-backward linkages for the purposes for use by KVIC.

22.2. KVIC will issue further guidelines in regard to utilization of funds for the purposes outlined in the backward and forward linkages by ensuring proper documentation etc., from KVIBs and DICs. Proper account of the expenditure in this regard will be maintained by State/KVIBs/DICs and monitored by KVIC regularly.

23. Proposed Estimated Targets under PMEGP

23.1 The following estimated targets have been proposed under PMEGP during the four years, i.e., from 2008-09 to 2011-12.

Year	Employment (in Nos)	Margin Money (subsidy)(Rs.crore)
2008-09	616667	740.00
2009-10	740000	888.00
2010-11	962000	1154.40
2011-12	1418833	1702.60
Total	3737500	4485.00

- Note:
1. An additional amount of Rs.250 crore has been earmarked for backward and forward linkages.
 2. To begin with, the targets would be distributed between KVIC (including State KVIBs) and State DICs in the ratio of 60:40 to ensure comparatively greater emphasis to micro enterprises in rural areas. The margin money subsidy would also be allocated in the same ratio. DICs will ensure that at least 50% of the amount allocated to them will be utilized in the rural areas.
 3. The annual allocation of targets would be issued State-wise to the implementing agencies.

23.2 Criteria for distribution of targets under PMEGP

The following are the broad suggested criteria for distribution of state-wise targets:

- (i) Extent of backwardness of State;
- (ii) Extent of unemployment;
- (iii) Extent of fulfillment of targets under PMRY and REGP in 2007-08;
- (iv) Extent of recovery of loans under PMRY and REGP in 2007-08;
- (v) Population of State/Union Territory; and
- (vi) Availability of traditional skills and raw material.

23.3 KVIC will assign targets to State KVIC Directorates/ KVIBs and State Governments. Target at District levels will be decided by State Level Bankers Coordination Committee. SLBCC will ensure that targets are evenly distributed within each district. The State-wise targets in respect of KVIC/KVIBs will be made available by KVIC to SLBCC where overall allocation of district-wise targets will be decided. Any modification of the targets for which KVIC is directly responsible will be permitted only with the concurrence of the Ministry. KVIC will identify the Nodal Bank Branches in consultation with State Governments and place the Margin Money (subsidy) with these branches both for rural and urban areas. For assigning the targets of subsidy and other parameters (number of units, employment opportunities, etc.) to KVIC Directorates / KVIBs, KVIC will adopt the criteria of rural population of the State, backwardness of the State (based on 250 backward districts identified by Planning Commission) and past performance of the State under REGP Scheme for deciding the targets as per weightages given below. Similarly, for assigning the targets to DICs, KVIC will adopt the criteria of backwardness of the State (based on 250 backward districts identified by Planning Commission), urban unemployment level (as reflected in the Planning Commission's report (2002) on 'Special Group on targeting ten million employment opportunities per year' and rural population of the State. From the second year (i.e., 2009-10) onwards, the performance of PMEGP during the previous year(s) will also be given appropriate weightage, for deciding the targets. The approximate weightages to be assigned for determining the targets to the implementing agencies are given below.

Criteria	Weightage for determining targets	
	KVIC/KVIBs	DICs
1. Rural Population of the State	40 %	30 %
2. Backwardness of the State	30 %	40 %
3. Urban Unemployment level	-	30 %
4. Past performance of REGP	30 %	-

24. Rehabilitation of Sick Units

Sick units under PMEGP for their rehabilitation will be linked with RBI's Guidelines for rehabilitation of sick small scale industrial units issued to all Scheduled Commercial Banks vide their letter RPCD.No.PLNFS.BC.57/06.04.01/2001-2002 dated 16th January, 2002.

25. Registration

Registration with the KVIC/KVIBs/State DICs under the Scheme is voluntary. No registration fee will be charged from the beneficiaries and the funds available under Forward and Backward linkage will be utilized to meet expenses on documentation cost, etc.

Beneficiary will submit quarterly report about production, sales, employment, wages paid etc. to the State/Regional Director of the KVIC/KVIB/State DIC, and KVIC will in turn analyze and submit a consolidated report to the Ministry of MSME, every six months.

26. Role of Private Sector (Scheduled, Commercial / Co-operative) Banks in the implementation of PMEGP

The Scheme will also be implemented through the Private Sector Scheduled Commercial Banks/Co-operative Banks on selective basis, after verification of intending Banks' last 3 years' Balance Sheet and ascertaining quantum of lending portfolio. Margin Money (subsidy) portion will be paid on actual reimbursement basis to the Banks by KVIC.

27. Monitoring and evaluation of PMEGP

27.1 Role of Ministry of MSME

Ministry of MSME will be the controlling and monitoring agency for implementation of the scheme. It will allocate target, sanction and release required funds to KVIC. Quarterly review meeting will be held in the Ministry on the performance of PMEGP. CEO, KVIC, Principal Secretaries / Commissioners (Industries) responsible for implementation of the Scheme in States through DICs, Representatives of State KVIBs and Senior officials of Banks will attend the meeting.

27.2 Role of KVIC

KVIC will be the single Nodal Implementing Agency of the Scheme at the National level. CEO, KVIC will review the performance with State KVIBs, DICs and Banks every month and submit a monthly performance report to the Ministry. The report will include the component wise details of beneficiaries indicating the amount of the Margin Money (subsidy) allotted, employment generated and the projects set up. KVIC will ensure that the margin money (subsidy) is utilized as per the sub component plans approved for SC, ST, Women, etc. The targets and achievement will also be monitored at the Zonal, State and District levels by the Dy.CEOs, Directors of KVIC and the Commissioner /Secretary of Industries (DIC), of the States concerned. The existing REGP units will continue to be

monitored by the KVIC as hitherto fore, and separate monthly report submitted directly to Ministry of MSME.

27.3 Role of State Governments / Union Territories

The Scheme will be reviewed half yearly by Chief Secretary of the State. Representatives KVIC, Ministry of MSME, State Director (KVIC) CEO, KVIB, Secretary / Commissioner (Industries) of the State, Senior Officials of the Banks and other officials concerned will attend the meeting. State Governments {Commissioners / Secretaries (Industries)} will forward their monthly reports to KVIC, specifying the component wise details of beneficiaries indicating the amount of the Margin Money (subsidy) allotted, employment generated and the projects set up, which will be analyzed, compiled and consolidated by KVIC and a comprehensive report forwarded to Ministry every month. The existing PMRY units will continue to be monitored by the State DICs, as hitherto fore, and report submitted directly to Ministry of MSME.

28. Evaluation of the Scheme

A comprehensive, independent and rigorous evaluation of the scheme will be got done after two years of its implementation. Based on the findings of the evaluation study the scheme would be reviewed.

29. Negative List of Activities

The following list of activities will not be permitted under PMEGP for setting up of micro enterprises/ projects /units.

- a) Any industry/business connected with Meat(slaughtered),i.e. processing, canning and/or serving items made of it as food, production/manufacturing or sale of intoxicant items like Beedi/Pan/Cigar/Cigarette etc., any Hotel or Dhaba or sales outlet serving liquor, preparation/producing tobacco as raw materials, tapping of toddy for sale.
- b) Any industry/business connected with cultivation of crops/ plantation like Tea, Coffee, Rubber etc. sericulture (Cocoon rearing), Horticulture, Floriculture, Animal Husbandry like Pisciculture, Piggery, Poultry, Harvester machines etc.

c) Manufacturing of Polythene carry bags of less than 20 microns thickness and manufacture of carry bags or containers made of recycled plastic for storing, carrying, dispensing or packaging of food stuff and any other item which causes environmental problems.

d) Industries such as processing of Pashmina Wool and such other products like hand spinning and hand weaving, taking advantage of Khadi Programme under the purview of Certification Rules and availing sales rebate.

e) Rural Transport (Except Auto Rickshaw in Andaman & Nicobar Islands, House Boat, Shikara & Tourist Boats in J&K and Cycle Rickshaw).

OPERATIONAL GUIDELINES

PMEGP SCHEME

9. Whether Entrepreneur Development Programme (EDP) (at least 2 weeks) undergone: (mark ✓)

Yes No

Name & Address of Training Institute	Period of training		Certificate Issue Date
	From	To	

10. Whether the applicant belongs to (mark ✓)

SC	ST	OBC	PHC	Ex-Serviceman	Minority	Hill Boarder Area	General

11. Whether the project for (mark ✓)

Manufacturing unit

Business/Service unit

12. Name of the project / business activity proposed:

13. Amount of loan required (in Rs.)

Building Type (own/ leased/ Rented)	Capital Expenditure Loan			Working capital/cash credit Limit	Total
	Work shed, Building etc	Machinery & equipment	. Pre operative Cost		

14. Details of earlier or current Loan/grant and subsidy availed from Central/state Govt. Scheme/or any other similar scheme.

Activity of the Project with Address	Amount(in Rs.)	Year of Sanction

I certify that all information furnished by me is true; and that I and any of my dependent have not borrowed any money under Subsidy Linked Scheme from any central/State Government or bank for establishing any such project.

Date :

Signature of the applicant

NOTE:

- **Own contribution must be invested 5% for SC/ST/OBC/PHC/woman/ Ex-serviceman/ North East Reason/Hill Boarder Area and 10% for General**
- **Total Project Cost should not exceed 25 lakhs for Manufacturing unit and 10 lakhs for Business/service unit.**
- **Applicant will not be entitled for additional Margin Money(Subsidy) in case of Own Contribution over and above the prescribed limit.**
- **VIIIth pass for Manufacturing Unit above Rs.10 lakhs project cost and under Service Sector above Rs.5 lakhs**
- **Application should be submitted complete in all respect along with attested copies of the following documents:**
 1. Certificate of qualification-academic and technical (if project cost above 5 lakhs under business/service industry or above 10 lakhs under Manufacturing industry)
 2. Relevant Certificate for SC/ST/OBC/Minority/Ex-Servicemen/PHC
 3. if Entrepreneur Development programme(EDP) training undergone (at least for two weeks) then submit photocopy of the certificate

For Official Use only (Rejected/ to be placed before District Task force committee)

Reasons (if rejected):

Place:

Signature, Name and Designation of Officer

Date:

KVIC/ KVIB/DIC

FLOW CHART – APPLICATION PROCESS

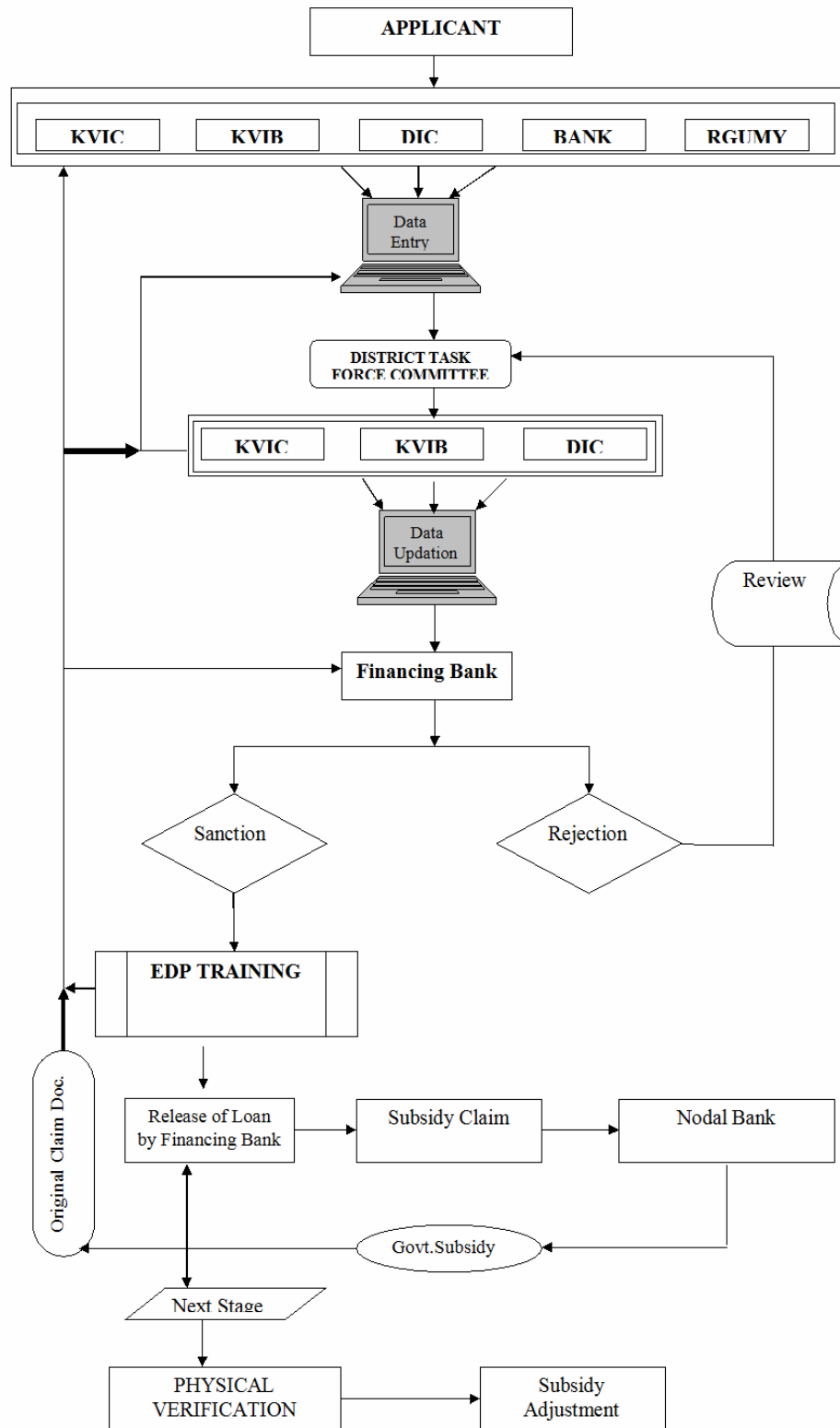

IDENTIFICATION OF POTENTIAL BENEFICIARIES

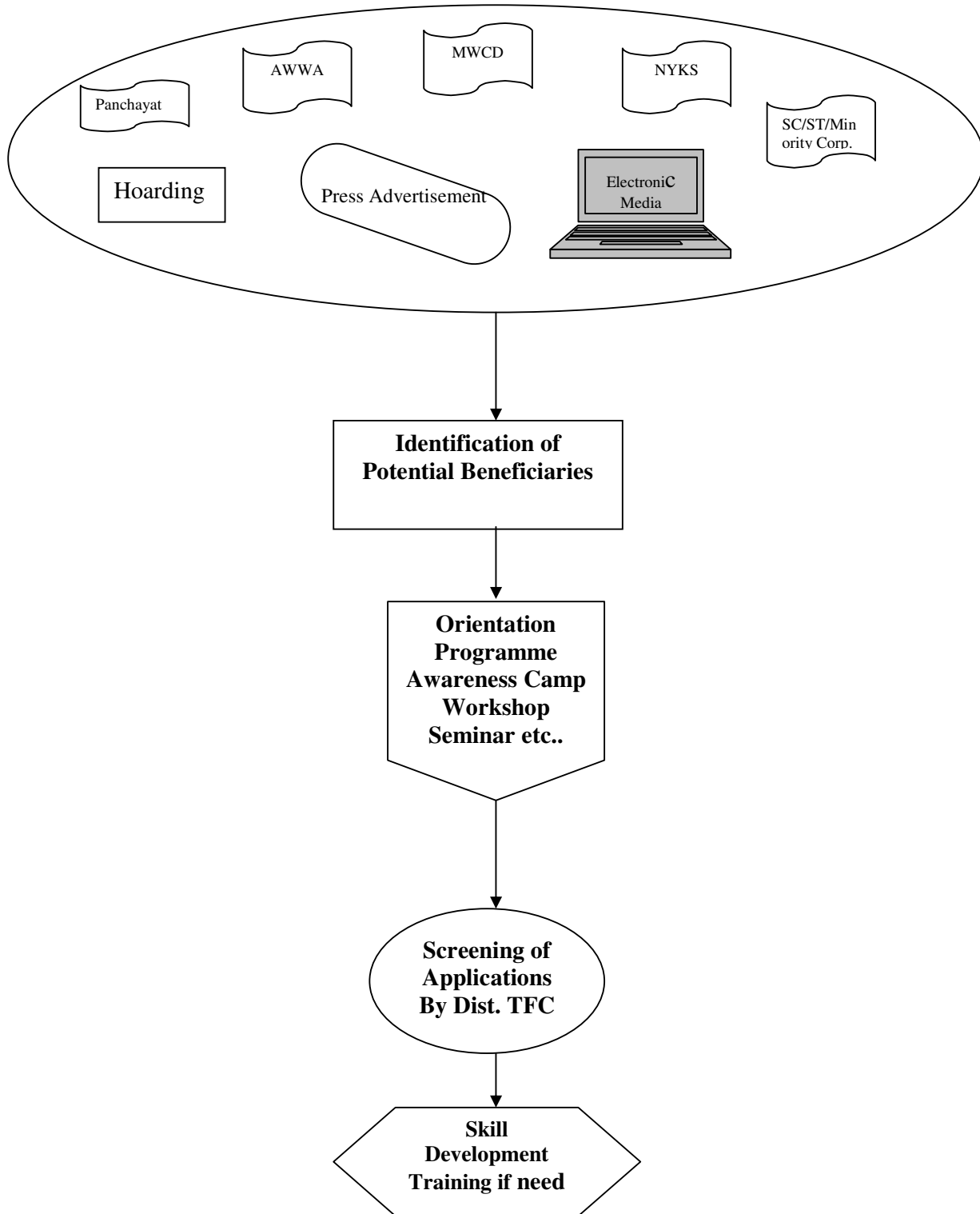

FLOW CHART – FUNCTION OF TASK FORCE COMMITTEE

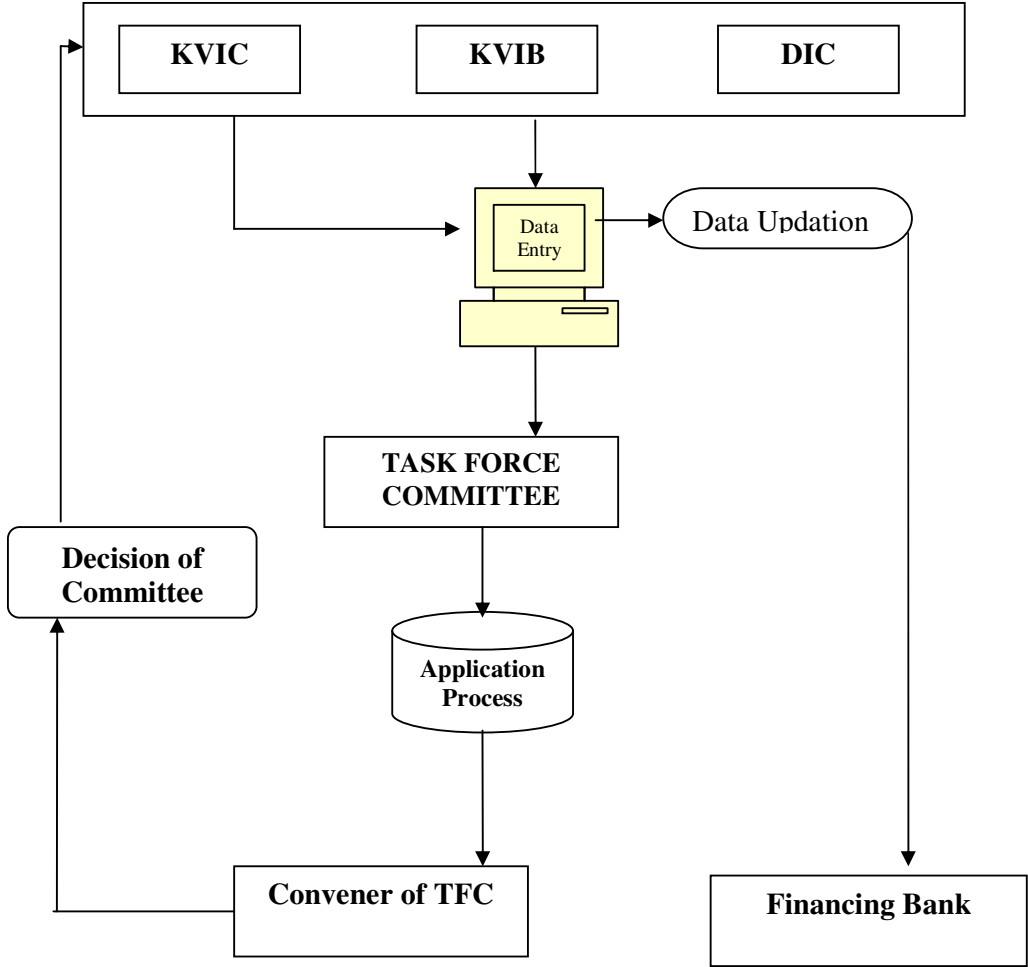

FLOW CHART – EDP TRAINING

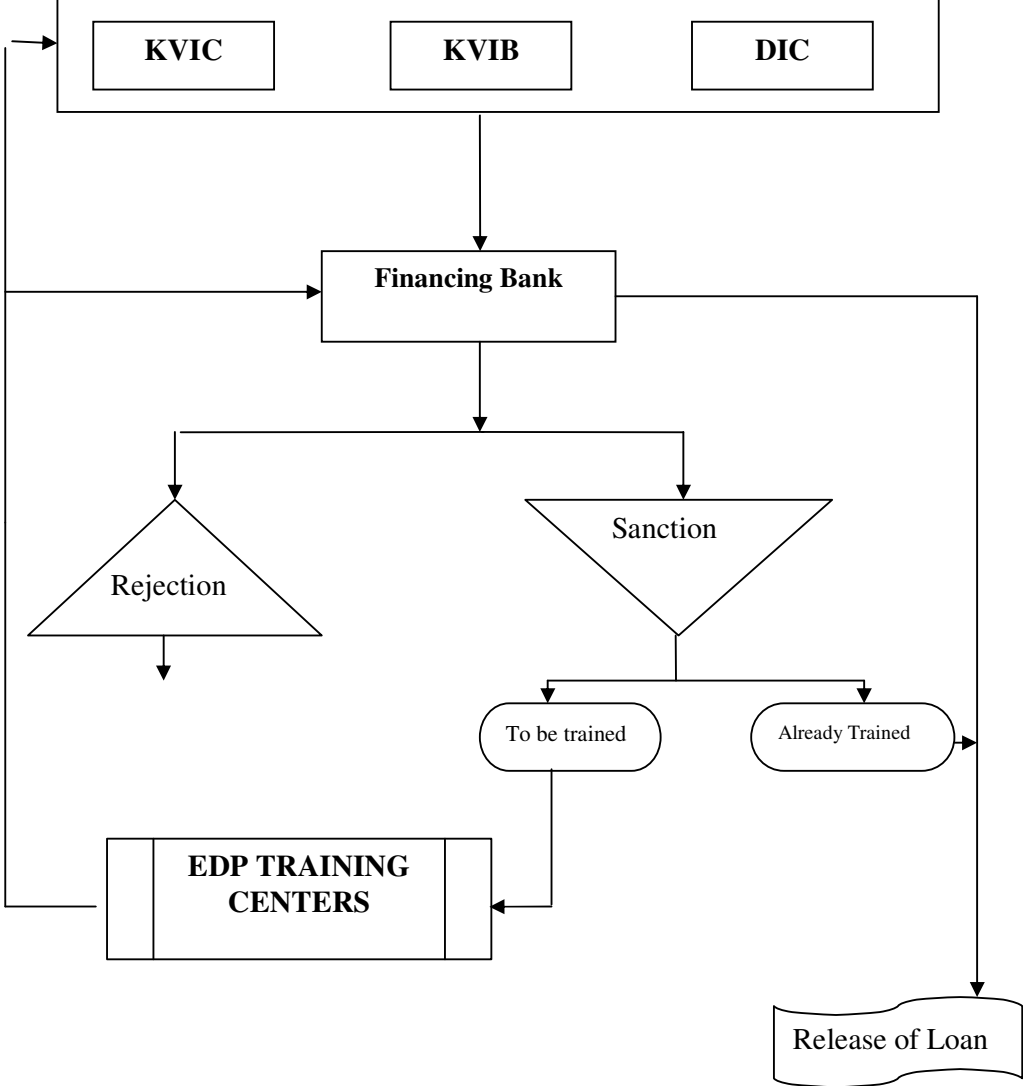

FLOW OF GOVT. SUBSIDY

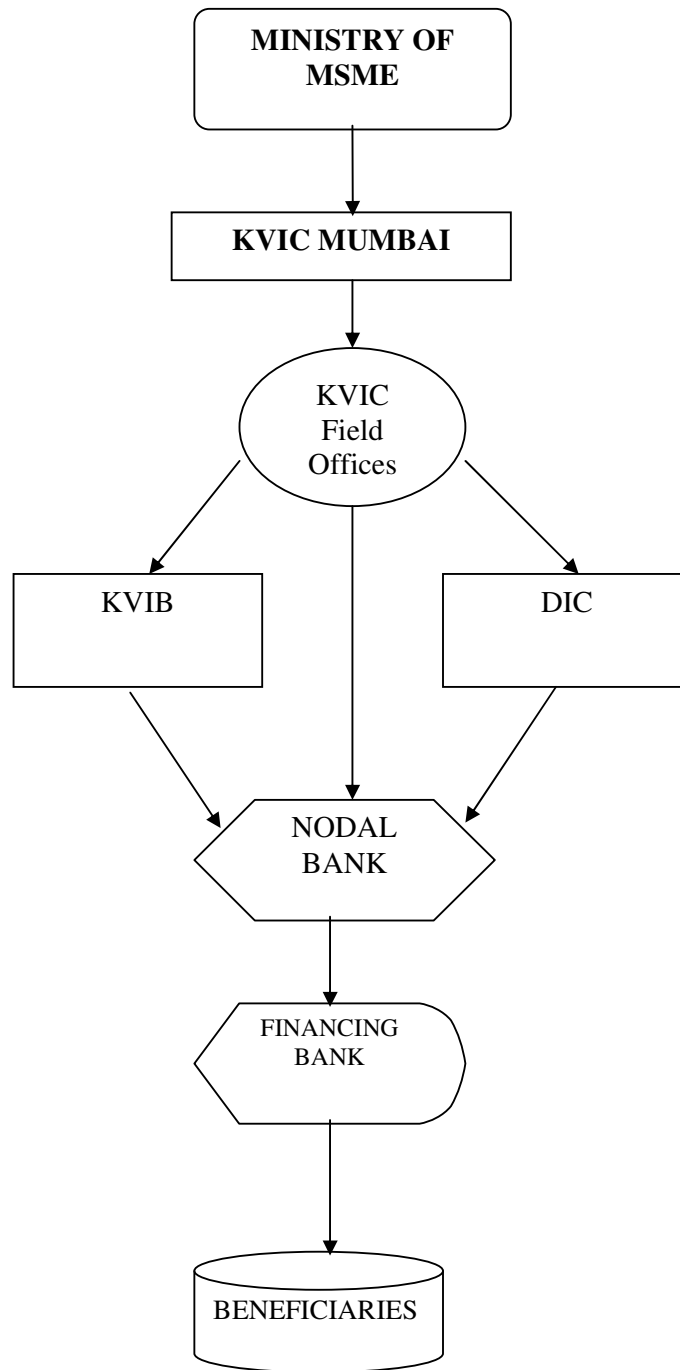

FLOW CHART - PHYSICAL VERIFICATION

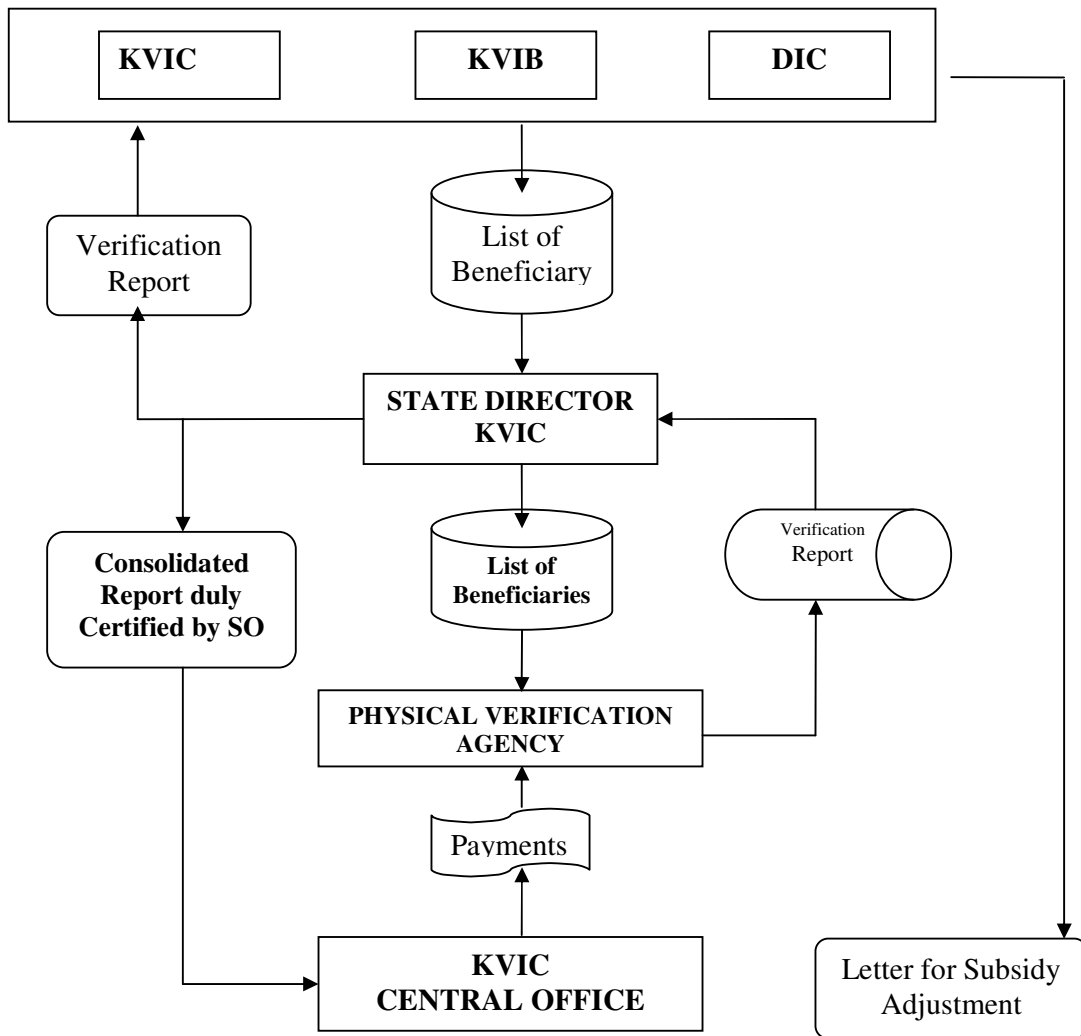

REPORTING SYSTEM

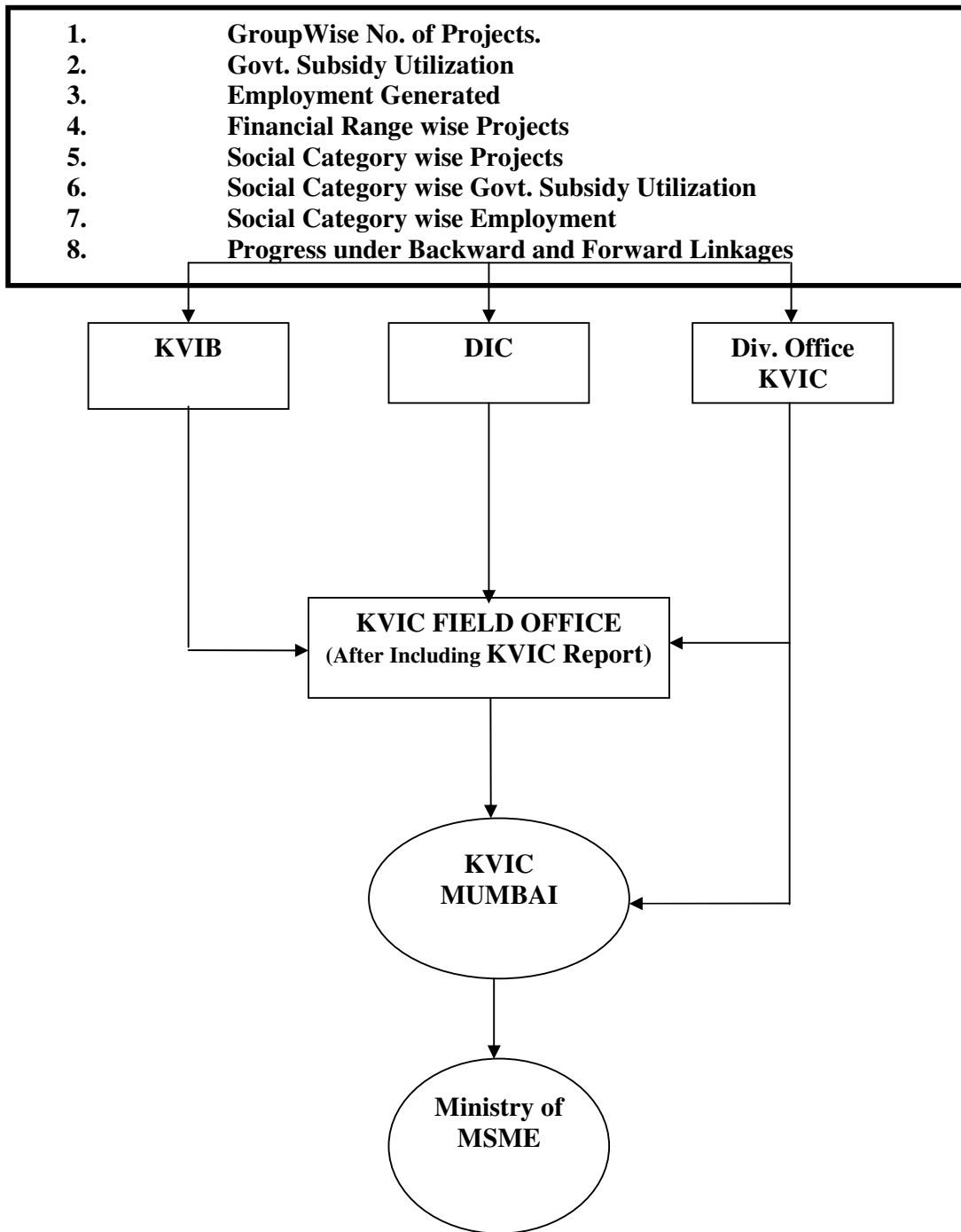

OPERATION OF BANK ACCOUNT UNDER PMEGP SCHEME

1. INTRODUCTION :

The Prime Minister's Employment Generation Programme is being implemented w.e.f. financial year 2008-09 by the Ministry of MSME, Govt. of India, New Delhi with Khadi & V.I. Commission being the Nodal Agency for implementation of the scheme. Under the scheme, Govt. Subsidy ranging from 15% to 35% will be provided for the projects financed by the Bank to the beneficiary. For the purpose, the Ministry of MSME will provide funds on yearly basis to KVIC.

2. Releases from the Ministry of MSME :

- i) The Ministry of MSME will release amount of Govt. Subsidy on installment basis to KVIC as per the allocation made for the year by the Government.
- ii) For releases of said funds, KVIC will put a demand before the Ministry. The said demand should be based on the target fixed for the year.

3. Flow of Funds from KVIC to field offices :

- i) Immediately after receipt of funds from the Ministry, the KVIC will release proportionate amount to all the State and Divisional offices of KVIC based on the target fixed for the States. The said release will be made after following the procedure as made in the KVIC Act.
- ii) A separate Bank account as main account i.e. KVIC-SO-PMEGP Savings Bank Account will be opened by all State offices for the purpose and all sorts of releases to PMEGP will be operated through this accounts only. Likewise, Divisional offices of KVIC will open main account on PMEGP known as KVIC-DO-PMEGP in the town where the Divisional Office is situated.
- iii) No other Bank accounts including the REGP Bank accounts already in operation at State / Divisional offices should be clubbed with this account and any return / refund / resource generation received by the State / Divisional offices on REGP should not be kept in the PMEGP Bank accounts. **It has to be a separate account for PMEGP only.**

4. Opening of Nodal Branch Accounts :

- i) The State Director in consultation with the lead Bank of the State, CEO, KVIB and Director, Industries of State Government will open three separate SB Accounts in the name of KVIC-PMEGP, KVIB-PMEGP and DIC-PMEGP in one Nodal Branch of each Nationalized Bank after obtaining advance stamped receipt from the authorized officers of KVIB and Director (Industries) of the State.
- ii) It is not compulsory to open accounts in Nodal branch of each Bank. It will be opened only on the basis of requirement and the Bank's operation considering the anticipated projects to be sanctioned by them, area of operation in the State, availability of number of branches etc. In other words, account will be opened only in the Banks who are likely to finance PMEGP projects and are expected to avail the Govt. Subsidy for those projects.
- iii) The Nodal Branch accounts should be in the State Capital only.
- iv) In case of Divisional offices of KVIC, only Nodal Branch account in the name of KVIC- DO- PMEGP will be opened in each Nationalized Bank as per their requirement within the jurisdiction of the Divisional offices will be opened and operated. However, the location of the Bank account of Nodal branch should be in the city/town where the Divisional office is located. This is for the purpose that the Divisional office will sanction Govt. Subsidy only in case of projects in respect of KVIC only.
- v) After opening of Nodal Branch Bank accounts, the same will be intimated by the State Director to the CEO, KVIB and Director, Industries with details like Bank account number, address of the Nodal branch and amount deposited etc.

5. Operation of Nodal Branch Bank Account :

- i) The State Director, KVIC will operate the KVIC Nodal branch Bank accounts either directly or through his authorized officer/s not below the rank of Asstt. Director.
- ii) In case of KVIB Nodal Branch Bank accounts and Director of Industries Nodal Branch Bank accounts, the said accounts will be non-operative accounts (without cheque facility) as previously in REGP. The State Director, KVIC will authorize the authorized officer/s of KVIB and Directorate of industries to operate their respective accounts through letter of transaction i.e. for transferring funds from Nodal Branch to Financing Bank.
- iii) Interest earned on the said accounts should be transferred to KVIC Main Accounts at State Level from time to time. This interest should not be utilized towards the payment of Govt. Subsidy.

- iv) The release of Govt. Subsidy to the Financing Branch from Nodal Branch will be made as per provisions of the Scheme.
- v) The Nodal Branch Bank accounts is to be operated exclusively for the purpose of release of Govt. Subsidy to the financed project and not for any expenditure under Backward Forward Linkages like EDP, Exhibition etc. The said expenditure under Backward Forward Linkages will be operated from separate accounts to be opened by KVIC, KVIB and DICs.

FUNCTIONING OF DISTRICT TASK FORCE COMMITTEE

1. Introduction:

- I. The Prime Minister's Employment Generation Programme is being implemented w.e.f. financial year 2008-09 by the Ministry of MSME, Govt. of India, New Delhi with Khadi & V.I. Commission being the Nodal Agency for implementation of the scheme. The scheme is being implemented through KVIC and KVIB's of the States in the rural areas and through DIC's in both Rural and Urban areas with an objectives to develop **"An improved system of identification of beneficiaries"**.
- II. It has been decided to have a transparent system of scrutiny of applications at the first stage, so that right beneficiaries are identified for availing bank loan for their project. Proper identification of beneficiaries with required skill, knowledge, attitude and aptitude will help in efficient management of the unit/enterprise and sustainability of the same in long run for the purpose. Starting from inviting applications to forwarding of the project to the bank will be made through a committee known as **"District Task Force"**.

2. Inviting Applications :

- I. The State Director, KVIC of the concerned states will issue an advertisement through local print and electronic media i.e. Regional News Papers, local T.V. Channels, Radio etc. for wider publicity at periodical intervals inviting applications from potential beneficiaries for sanction of projects under PMEGP Scheme. Details of office address of KVIC/KVIB/DIC may also be given for submission of applications, to enable the beneficiaries living in remotest area.
- III. Apart from issuance of advertisement to the effect, the State Director may also take help of NYKS, SC/ST/Minority Finance & Development Corporations, MWCD, AWWA, Panchayati Raj Institution etc. for mobilization of applications and forward the same to the designated authorities.
- IV. A standard Application format and advertisement have been devised by KVIC and all the prospective entrepreneurs may be instructed to apply in the said format only which is enclosed.
- IV. Based on the standardized format of applications and advertisement in English, the concerned State Director may get it translated into regional language and issue advertisement accordingly.

- V. Under the PMEGP Scheme, a beneficiary can avail Govt. subsidy either through KVIC or KVIB or DICs. While submitting applications, the beneficiary may have to make a choice in this regard and it should be clearly mentioned in the application format.
- VI. Based on his choice of avilment of Govt. Subsidy on his project, the beneficiary will have to submit the application either at KVIC or KVIB or DIC for the purpose.

3. Preliminary scrutiny of applications

- 1. A preliminary scrutiny may be made at the initial stage by the concerned State/Divisional Director in case of KVIC, authorized officer/Committee in case of State KVIB and DICs so as to ensure the fulfillment of laid down criteria, if any fixed. It may be ensured that the beneficiary has not taken benefit of any other subsidy scheme of Central / State Govt. and if so, the said applications may be out-rightly rejected. The said applications will be kept in custody of the rejecting officer/committee and a summary of such cases alongwith reason be placed before the District Task Force for their final approval/ rejection. Only the District Task Force will have the power to reject any application.
- 2. All the applications received by KVIC/KVIB/DIC will be placed before District Task Force.

4. District PMEGP Task Force :

- I. A District Level "District PMEGP Task Force" for the purpose of scrutiny of applications and finalizing the beneficiaries to be sanctioned with project under PMEGP Scheme will be formed. The Committee consists of the following members :
 - a. District Magistrate/Deputy Commissioner/Collector - Chairman
 - b. Lead Bank Manager - Member
 - c. Representative of KVIC - Member
 - d. Representative of KVIB - Member
 - e. Representative of DIC - Member
 - f. Representative of NYKS/SC/ST/Women Corpn. - Spl. Invitee
 - g. Representative of MSME-DI/ITI/Polytechnic - Spl. Invitee
 - h. Representatives from Panchayats - 3 members
(To be nominated by Chairman/Dist.Magistrate/
Dy. Commissioner /Collector by rotation. every year)
 - i. General Manager, DIC or Rep. of KVIC or
Rep. of KVIB - Member Convenor

NB : 1)The Committee will meet once in two month or as decided by the Chairman of the Committee i.e. District Collector based on the target of the district and the no. of applications received.

- II. All the applications collected from different sources i.e. KVIC/KVIB and DIC will be placed by the Member Convener of the Committee for consideration before the committee.
- III. The Committee will scrutinize applications and will either accept or reject as the case may be.
- IV. Based on the final list of applications found eligible, the Committee will start finalizing the applications for recommendation to banks based on the target and Govt. subsidy sanctioned. Under no circumstances, the no. of applications forwarded and subsidy involved should exceed the proportion of the sanction made in favour of that particular district in respect of Govt. subsidy. The process should be completed within a period of 30 days positively except in situation like natural calamities, or any other emergent situation in the district like elections and law and order problem etc.

5. Selection Procedure

- I.** The Committee will decide the applications on the basis of
 - 1) The information provided by the prospective beneficiary in the applications itself and 2) By conducting personal interview of the person concerned.
- II.** The recommendations of beneficiary for sanctioning purpose will be based on technical qualification, skill, past experience, geographical location and aptitude of the person in case of projects in manufacturing sector. In case of Service Industries, locational advantage, demand of that Service/Business in that particular area and aptitude of the person will be taken into consideration.
- III.** The District Task Force must take into consideration the reservation made by the Govt. in respect of Weaker Sections of Society such as SC/ST/OBC/Women/PHC/Minority/Ex-Servicemen etc. while making the recommendations. The said criteria may be strictly followed. To encourage different type of industries, the Group Industrywise projects criteria as fixed by the Commission from time to time should also be adhered. The purpose is to provide proper representation in PMEGP

Scheme both in social category as well as proper spread of various industry.

- IV.** However, in case sufficient no. of eligible candidates are not available in a particular category and Govt. subsidy may remain unutilized, the District Task Force in the last quarter may recommend the projects of other Category candidates for sanctioning purpose. The objectives are to fully utilize Govt. subsidy amount, establishment of projects and generate employment thereby.

6. Colour Coding:

- i) Once the list of beneficiaries are finalized by the District Task Force, the applications are to be bifurcated on the basis of the beneficiary choice of organization for availing Govt. Subsidy facility i.e. KVIC, KVIB and DIC.
- ii) The colour form for KVIC should be White, for KVIB it is yellow and for DIC it is sky blue.
- iii) The concerned State Office of KVIC/KVIB/DIC should print the colour forms in sufficient number from time to time. The expenditure for printing will be met out by the funds being provided for Publicity under Backward & Forward Linkages .

7. Minutes of the meeting

- I. The minutes of the meeting should be prepared by the Member Convenor and duly signed by all the members present in the meeting.
- II. The minutes should consist the following.
 - a) No. of members present in the meeting alongwith date and venue
 - b) No. of applications received.
 - c) No. of applications rejected at the time of scrutiny and the reasons thereof in clear terms.
 - d) No. of applications rejected after interview and the reasons thereof in clear terms.
 - e) No. of applications recommended showing name, address, project name of the financing branch, qualification details etc. in a chart form.
 - f) Chart showing social categorywise, industrywise beneficiaries, proper representation to all corners of the district.

8. General

- I. After the decision by the District Task Force, the Member Convener will forward those applications to the concerned State/Divisional offices of KVIC/State KVI Boards and DICs for forwarding the same to the financing branch as per the choice made by the applicant within 7 days of the meeting. The concerned offices will forward the same to the financing branch within 7 days of the receipt of the same. In case no such choice of the financing branch and bank is made by the applicant, respective offices may forward the same to the nearest branch of any bank close to the residential address/site of the project of the beneficiary.
- II. Recommendations made by the District Task Force does not entail a person to be automatically selected for financing by the Bank and availment of Govt. subsidy. He/She has to fulfill the other conditions to be fixed by the Bank for financing purpose. However, the said conditions should be realistic and the bank may provide the reason either to the District Task Force or to the Lead Bank Manger, so that the same can be discussed in the next District Task Force for a final decision in the matter.
- VI. From receipt of applications to forwarding of the same to financing branch, all the data should be entered into Online Tracking Application System devised by KVIC . A separate guidelines on the same is being issued shortly.
- VII. The time frame for selection and forwarding should be strictly adhered to.
- VIII. Identification proof such as Voter Card, Ration Card as required under law should be made compulsory and be produced at the time of interview and duly attested zerox copy of the same should be provided by the beneficiary at the time of application.
- IX. The documentation from receipt of applications to forwarding of applications should be done on Online Basis providing necessary details, for which guidelines are being issued separately. Till the on line process is being operational, it may be done manually.

ENTREPRENEURSHIP DEVELOPMENT PROGRAMME FOR PMEGP BENEFICIARIES

1. INTRODUCTION :

Ministry of Micro, Small & Medium Enterprises, Govt. of India in a revolutionary step has decided to merge both the Central sponsored subsidy scheme i.e. PMRY and REGP into one scheme named as 'Prime Minister Employment Generation Programme' (PMEGP). As per the operational guidelines, a beneficiary has to undergo mandatory two weeks Entrepreneurship Development Programme (EDP) before release of first installment of the loan. Previously, the said training for REGP beneficiaries is of 3 days duration and the beneficiary has to undergo the training after release of first installment of loan. The main objective of the training programme is to motivate, inspire, develop confidence and build capacity for establishment of an enterprise, manage and sustain the unit successfully.

2. OBJECTIVES:

- To impart knowledge on the concept of entrepreneurship, its challenges and prospects
- To develop entrepreneurial competencies of viz., achievement motivation, risk taking ability, confidence, goal setting ability of the potential entrepreneurs.
- Impart knowledge on procedure and formalities of setting of an enterprise/ business.
- Develop skills on management of a unit/ business establishment including financial and marketing.
- To impart knowledge on identification of business opportunities and preparation of business plan.

3. DURATION :

Two weeks (10 working days)

4. ELIGIBILITY :

Beneficiaries of PMEGP scheme whose projects have been sanctioned and the first installment have not been released. The training programme is mandatory for release of first installment of loan to the selected beneficiaries of PMEGP scheme.

EXEMPTION :

Beneficiaries who have already undergone similar training at any EDP institute of repute i.e. National or State level for a period of minimum 2-3 weeks are exempted from attending the said training.

5. ELIGIBLE INSTITUTIONS FOR IMPARTING TRAINING:

- Departmental Multi Disciplinary Training Centers of KVIC and KVIBs.
- Non-departmental Training Centers functioning under the administrative control of KVIC and KVIBs.
- Training Institutes / EDP institutes/ Educational Institutions accredited by KVIC for the purpose.
- Recognised Training Institutes of District Industries centers.

N.B : A list of accredited training institutes for the purpose may please be seen at web-site www.pmegp.in

6. CURRICULUM:

The topics to be covered during the course includes:-

- i) Becoming an entrepreneur ; Challenges ahead
- ii) Entrepreneurial competencies; Achievement motivation and Attitude building, developing confidence.
- iii) Establishment of an enterprise; identification of Business opportunity and business plan preparation.
- iv) Enterprise management ;
- v) Managing the scarce finance; financial planning and accounts maintenance.
- vi) Marketing the product;
- vii) Statutory laws, rules and regulations of Government to be followed/ abide by the entrepreneur.
- viii) Expansion, growth and sustainability of the enterprise;

7. **COURSE PLAN:**

DURATION -TWO WEEKS.

PERIODS - 40

1st Session - 09.30 to 11.15 hrs.

TEA BREAK

2nd Session -11.30 to 01.15 hrs.

LUNCH

3rd Session - 14.00 to 15.45 hrs

TEA BREAK

4TH Session -16.00 to 17.45 hrs.

Days	1st Session	2nd Session	3rd Session	4th Session
1	Registration & Inauguration	Rapport building & Unfreezing	Entrepreneurship; Charms & Challenges	Characteristics of an entrepreneur; A matter of attitude and skill.
2	Internalizing of entrepreneur competencies; Thematic Appreciation test (TAT)	Continued	Continued	Continued
3	Risk Taking behavior	Problem solving and creativity	Communication	Leadership
4	Business plan preparation	Establishment of an enterprise; Systematic approach	Legal formalities for setting up of the unit	Resource mobilization and support system; Role of supporting organizations.
5	Managing the enterprise; Purchasing, inventory/ material management.	Quality management	Design and Packing	Manpower management
6	SATURDAY: Visit to a Small Scale Industry preferably run by a successful entrepreneur.			
7	SUNDAY:			
8	Accounts & Book-keeping:	Continued	Working capital management.	Break even analysis
9	Costing, Pricing and profit management.	Marketing strategy and Sales Techniques.	Continued	Customer management.
10	Time Management	Sustainability of an unit; Precautions needed	Enterprise growth; Product diversification and expansion	Continued
11	Crisis management.	IT factor for managing an unit; An impending need	Union & State laws to be followed by an unit; Sales Tax, Vat, Income Tax etc.	Continued.
12	Interaction with a successful entrepreneur/s; his experience of establishment / managing an unit.	Continued	Programme Evaluation	Valedictory

Total working days : 10

One day for study visit

8. BATCH SIZE :

20 Trainees per batch.

9. EXPENDITURE PER BATCH :

i) Training Centers of KVIC/KVIB/DIC those who are receiving grant for recurring/non-recurring expenditure either from State or Central Government.

a) Boarding -

$Rs.120 \times 20 \times 14 \text{ days} = Rs.33,600/-$

b) Lodging - Free

c) Guest faculty -

$35 \text{ Session} \times Rs.500 = Rs.17,500/-$

d) Study material -

$20 \times Rs.200 = Rs.4,000/-$

e) Stationery -

$20 \times Rs.100 = 2,000/-$

f) Miscellaneous Expenditure -

$20 \times Rs.200 = Rs.4,000/-$

g) Incentive to institute - Rs.5,000/- per batch.

Expenditure per batch:

ii) Training Centres those who are not receiving any grant either from State or Central Government.

a) Lodging of participants including Hall charge -

$Rs.1,000/- \text{ per day i.e. } 15 \text{ days} = Rs.15,000/-$

b) Boarding - $Rs.120 \times 20 \times 14 \text{ days} = Rs.33,600/-$

c) Guest faculty -

$35 \text{ Session} \times Rs.500 = Rs.17,500/-$

d) Study material -

$20 \times Rs.200 = Rs.4,000/-$

e) Stationery -

$20 \times Rs.100 = 2,000/-$

f) Miscellaneous Expenditure -

$20 \times Rs.200 = Rs.4,000/-$

g) Incentive to institute - Rs.5,000/- per batch.

SUM TOTAL OF EXPENDITURE PER BATCH

(In Rs.)

Sr.No.	Head of Expenditure	KVIC/KVIB Training Centres	Accredited Training Centers
1	Lodging of Participants	Free	15,000
2	Boarding	33,600	33,600
3	Guest faculty	17,500	17,500
4	Study material	4,000	4,000
5	Stationery / Printing etc.	2,000	2,000
6	Misc. expenditure	4,000	4,000
7	Incentive to Institute	5,000	5,000
TOTAL :		66,100	81,100

Inter change of expenditure from one head to another is permitted within overall allocation.

Per head expenditure at KVIC/KVIB/DIC Training Centers who are receiving grant either from State or Central Government : Rs.3,305/-
Per head expenditure at Training Centers who are not receiving any grant either from State or Central Government :Rs.4,055/-

10. **EVALUATION:**

i) Immediately after completion of EDP, the participants may be instructed to fill up the Evaluation Form in the format provided to them in the last day of programme.

ii) The evaluation format should be submitted to KVIC officials only.

ii) Based on said Evaluation Reports submitted by the participants separately, the course evaluation reports will be prepared by the state/ divisional director and it may submitted to the Director, PMEGP and Director, HRD within 15 days of the completion of the course.

11. **GENERAL :**

i) Banks will sponsor beneficiaries for EDP training either to Departmental and non-departmental training centres of KVIC or to the accredited training centre. Once the training is completed, training centre will have to send the expenditure statement duly certified to the concerned State Office of KVIC.

ii) The expenditure on EDP will be reimbursed by concerned State Office, KVIC directly to EDP training centre.

iii) While inviting guest faculties, preference and best efforts should be made to invite persons having requisite qualifications and experience needed for the particular topics. Further Government officials and entrepreneurs having long experience may be invited for delivering lecture on the topics such as taxation laws, laws to be followed for establishment of an enterprise etc.

PMEGP Online Application Tracking System

The Directorate of Information Technology, Khadi & Village Industries Commission, Mumbai has designed and developed the web based **PMEGP online application tracking** to monitor the scheme and also tracking the status of application at beneficiary level. The system will facilitate to view the application status at any point of time through internet and generate various reports from time to time by implementing agencies, KVIC central office and Ministry of MSME. The system can track the status of application right from submission and till adjustment of Govt.Subsidy.

SEPARATE GUIDLINES ON THE SYSTEM IS BEING ISSUED SHORTLY

PHYSICAL VERIFICATION OF PMEGP UNITS

Ministry of Micro, Small & Medium Enterprises, Govt. of India in a revolutionary step has decided to merge both the Central sponsored subsidy scheme i.e. PMRY and REGP into one scheme named as 'Prime Minister Employment Generation Programme' (PMEGP). The REGP scheme was in operation till 31-3-2008. As per the guidelines of PMEGP Scheme the physical verification of the units established is compulsory. The said verification is to be completed in respect of the units within 24 months of establishment of the units. Considering the limitations of manpower, it has been decided to conduct physical verification by outsourcing reputed National / State level agencies.

SEPARATE GUIDELINES ON THE SYSTEM IS BEING ISSUED SHORTLY

REPORTING AND MONITORING

1. Introduction:

The Prime Minister's Employment Generation Programme is being implemented w.e.f. financial year 2008-09 by the Ministry of MSME, Govt. of India, New Delhi with Khadi & V.I. Commission being the Nodal Agency for implementation of the scheme. As per the guidelines of the scheme Ministry of MSME will be the Controlling and Monitoring Agency for implementation of the Scheme. KVIC being the Nodal Agency for implementation will report to the Ministry on periodical basis which will be reviewed and further suggestions, change or modification for smooth implementation of the scheme will be made by the Ministry.

2. Reporting :

- i) The PMEGP Scheme will be implemented in the field through KVIC, KVIB and DICs of State Government. Statewise targets will be allocated to them on yearly basis and the said target will be reallocated Districtwise & Bankwise as per approved criteria in consultation with State Level Bankers Committee.
- ii) KVIB and DICs of the States will report to the State Director, KVIC of the concerned States on monthly basis on the performance / achievement made by them in the particular month in a prescribed format . The said report invariably reaches the State Director latest by 3rd of every month for the previous month.
- iii) The said information includes
 - a) Achievement in respect of Group wise number of projects
 - b) Govt. Subsidy utilization
 - c) Employment Generated
 - d) Financial Range wise and Social Category wise projects.
 - e) Social Category wise Govt. subsidy utilization and Employment generated.
 - f) Progress under Backward and Forward Linkages
 - g) In case of non achievement of targets, reasons to be specified and action plan for completing the backlog.

- iv) The said information should also be put in the web based reporting system devised by KVIC.
- v) The concerned State Director, KVIC by including its performance of the reporting month will prepare a consolidated report and send it to the Director (REGP/PMEGP) latest by 5th of every month.
- vi) The Divisional Offices of KVIC will send the performance report directly to Director (REGP/PMEGP) latest by 5th of every month.
- vii) The State / Divisional offices of KVIC will send the performance report every month only through web based reporting system.
- viii) The Director (REGP/PMEGP) will scrutinize and consolidate reports received from State and Union Territories. A Statewise consolidated report will be sent to Ministry of MSME latest by 10th every month.

3. Monitoring

There will be four tier monitoring system on implementation of the scheme.

- A) State Level
- B) Zonal Level
- C) National Level
- D) Ministry of MSME level

A) State Level Monitoring

- i) There will be State Level Monitoring committee which will consists of the following members for reviewing the performance of PMEGP scheme.
 - a) Principal Secretary/IDC, Dept. of Industries - Chairman
 - b) Director of Industries - Member
 - c) CEO, KVIB - Member
 - d) Rep. of major public sector Banks in the State - 5 Members
 - e) Rep. of SC/ST Corporation - Member
 - f) Rep. of Dept. Panchayati Raj - Member
 - g) Rep. of State Women Dev. Corp. - Member
 - h) Divisional Directors of KVIC in State - Member
 - i) Rep. of SIDBI - Special invitee
 - j) Rep. of NABARD - Special invitee
 - k) State Director, KVIC - Member Convenor

- ii) The State Level Monitoring Committee will meet at least once in a quarter.
- iii) The functions of the committee includes
 - a) to review the performance / achievement made in implementation of PMEGP by KVIC / KVIB / DIC separately in the quarter. The review should focus on total achievement in relation to target, imbalance, if any in social category wise, industry wise and Area wise and action taken from wider publicity of the scheme.
 - b) Suggest ways for improving performance and to correct the imbalances, if any.
 - c) The Committee should ensure that the performance of PMEGP are regularly reviewed in the District Consultative Committee (DCC) / District Level Review Committee (DLRC) headed by District Collector / District Magistrates by including it as permanent agenda point.
 - d) Reviewing the reporting system made by KVIC, KVIB and DICs.
 - e) To review the sanction made by the Bank in relation to the recommendations made by District Task Forces.
 - f) Imparting of EDP training to selected beneficiaries.
 - g) Any other matter related to PMEGP scheme.
- iv) The expenditure on the meeting of the said committee will be met out by the State Office, KVIC as per approved guidelines.

B. Zonal Level Committee

- i) The Zonal Level Committee will review the performance / achievement made in the PMEGP scheme. The said committee comprises of following members :
 - a) Chief Executive Officer, KVIC : Chairman
 - b) Director of Industries in each State of the Zone : Members
 - c) CEOs of State / UTs KVIBs : Members
 - d) Lead Bank Managers of each State : Members
 - e) State / Divisional Directors of each State :
in the Zone : Members
 - f) Zonal Dy.C.E.O. of KVIC : Member Convenor

- ii) The committee will meet atleast once in a quarter.
- iii) The functions of the committee includes
 - a) to review the performance / achievement made in implementation of PMEGP by KVIC / KVIB / DICs of each State in the Zone separately on quarterly basis.
 - b) Reviewing the reporting system made by KVIC, KVIB and DICs.
 - c) To review the sanction made by the Bank in relation to the recommendations made by District Task Forces.
 - d) Imparting of EDP training to selected beneficiaries.
 - e) Any other matter related to PMEGP scheme.
- iv) The expenditure on the meeting of the said committee will be met out by the State Office of KVIC in the Zone where the meeting is being held as per approved guidelines for Backward & Forward Linkages.

C. National Level Committee

- i) The National Level Monitoring Committee consists of following Members :
 - a) Hon'ble Chairman, KVIC : Chairman
 - b) Chief Executive Officer, KVIC : Member
 - c) Financial Adviser of KVIC : Member
 - d) Rep. of MSME : Member
 - e) CMDs of all Public Sector Banks : Members
 - f) CEOs of State/UT KVIBs : Members
 - g) Director of Industries of State Govts. : Member
 - h) Rep. of RBI : Member
 - i) Zonal Dy.C.E.O.s of KVIC : Members
 - j) Director, REGP/PMEGP : Member Convenor
- ii) The Committee will meet once in six months.
- iii) The functions of the committee includes :

- a) To review the performance / achievement made in implementation of PMEGP, Statewise / Bankwise.
 - b) Suggesting policy measures and changes for smooth implementation of the scheme.
 - c) Any other matter in relating to implementation of PMEGP with permission of Chair.
- iv) The expenditure on the meeting of the said committee will be met out by Director, REGP/PMEGP as per approved guidelines.

D. Monitoring by Ministry of MSME, Govt. of India.

The meeting will be chaired by Secretary, Ministry of MSME, Govt. of India to review and monitor the overall implementation PMEGP Scheme in the country and to take policy decisions. Following are the participants :

- a) Principal Secretaries /IDC of Dept. of Industries of all State Governments/ U.T. Administrations
- b) Chief Executive Officer, KVIC
- c) CMDs of all Public Sector Banks

The expenditure on the meeting, any other meetings being conducted by the Ministry in connection with PMEGP scheme and also the advertisement being issued by the Ministry of MSME on PMEGP will be met by the KVIC out of funds available under Backward & Forward Linkages head of PMEGP.

GUIDELINES FOR ALLOCATION OF TARGETS

1. Statewise Target Allocation will be made by Central Office, KVIC, Mumbai. The total subsidy sanctioned by the Ministry of MSME under PMEGP, 10% of the same is earmarked for giving additional subsidy dose to backward States. Out of remaining, 60% will be implemented through KVIC and KVIB in rural areas and remaining 40% will be implemented through DIC in both rural and urban areas.

2. The total subsidy has been allocated on 60:40 basis between KVIC, KVIB and DICs to all State / UTs proportionately on the basis of total population of the State / UT as per Census of India 2001.

3. In case of KVIC field offices / KVIBs, 60% of the allocation is reallocated on the basis of rural population of the State, Backwardness of the State (based on 250 backward Districts identified by Planning Commission) and past performance of the State under REGP Scheme. Similarly, remaining 40% of the allocation for assigning the targets to DICs, the criteria adopted is backwardness of the State (based on 250 backward districts identified by Planning Commission), urban unemployment level (as reflected in the Planning Commission's report (2002) on "Special Group on Targeting Ten Million Employment Opportunities As per Year" and Rural Population of the State.

The 10% of total kept for giving additional dose to backward States have been allocated for both KVIC / KVIB and DICs proportionately as per backwardness of the States.

The approximate weightages assigned for determining the targets to the implementing agencies are given below :

Criteria	Weightage for determining targets	
	KVIC /KVIBs	DICs
1. Rural population of the State	40%	30%
2. Backwardness of the State	30%	40%
3. Urban unemployment level	--	30%
4. Past performance of REGP	30%	--

4. Reallocation of targets at State Level

- i) After receiving the Statewise targets, the State / Divisional Director, KVIC, CEO / UT KVI Board and Director of Industries of respective State Govts. will jointly reallocate the States target among the

Districts in consultation with SLBC. If needed, SLBC may be requested for a special meeting for this purpose.

- ii) While allocating the targets Districtwise, for KVIC and KVIB, the criteria to be adopted is rural population of the District, Backwardness of the District and past performance of the Districts under REGP Scheme. In case of DICs, backwardness of the District, urban unemployment level and rural population of the District may be taken into consideration.

The approximate weightages assigned for determining the targets to the implementing agencies at District level are given below :

Criteria	Weightage for determining targets	
	KVIC /KVIBs	DICs
1. Rural population of the District	40%	30%
2. Backwardness of the District	30%	40%
3. Urban unemployment level at District	--	30%
4. Past performance of REGP in the District	30%	--

5. The targets allocated to KVIC and KVIB are bifurcated on 50:50 basis except in the State of Jammu and Kashmir, Goa, Mizorum, West Bengal and Nagaland. In these States, the targets between KVIC and KVIB are allocated in the ratio of 30:70.
6. The calculation of number of projects, the average subsidy per project is taken as Rs.1.20 lakhs.
7. For calculation of employment, the average employment per project is estimated at 10 persons.

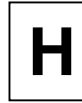

SPECIMEN ADVERTISEMENT FOR INVITING APPLICATIONS

For creation of Self Employment Opportunities, Khadi and V.I. Commission is implementing Prime Minister's Employment Generation Programme (PMEGP). The Scheme aims at establishment of new enterprise to be financed by the Bank. Subsidy ranging from 15 % to 35% will be provided on the Project cost of the unit.

Applications are invited from Unemployed Youths above the age of 18 years in the prescribed format available with Office of KVIC _____ or KVIB _____ and all District industries Centres.

The application can also be downloaded from KVIC website- www.kvic.org.in.

Persons or their family members already availed subsidy/ Margin Money under PMRY/REGP or any other central/State subsidy scheme are not eligible.

State Director

Note : May be translated in Regional language and be advertised.

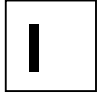

BACKWARD AND FORWARD LINKAGES

DISTRICT LEVEL AWARENESS CAMPS :

These camps are to be arranged jointly by KVIC/KVIB/DIC in the district.

1. Participants

- i) KVIC officials
- ii) State KVIB officials
- iii) DIC officials
- iv) Revenue Officer
- v) Local Bank Officials
- vi) Local NGOs
- vii) Representatives of Panchayats
- viii) Prospective Entrepreneurs

2. Duration of Camps

4 to 6 hours

3. Topics to be covered

- a) The KVIC official has to explain about KVIC, its aims and objectives, its functions and commitment in the rural and urban areas, the role of DICs, the role of the KVIC in rural industrialization in detail, the significant achievement of KVIC and then make a presentation, preferably through power point about the details of the Scheme and its operation procedure.
- b) To make aware about different circulars instructions issued on the Scheme by KVIC to the participants, if necessary by providing them copies of thereof. Material/Computer floppy on Scheme's presentation through Power Point may either be prepared in the Local language or English/Hindi version of the Scheme may be collected from the Central Office to have uniformity of presentation through out the country. However, wherever necessary modification may be made to suite the local requirement.
- c) After initial introduction as above, the KVIC/KVIB/DICs official has to throw open the subject matter for open house discussion, where they have to give required clarification on the points raised or has to solve the problems faced by the PMEGP entrepreneurs.
- d) The KVIC/KVIB/DICs official has to introduce a successful entrepreneur in the camp to share his experience with others.
- e) They should open a discussion on locally available raw material based Industries and on other potential industries in the area.

- f) Group wise Industry wise targets already communicated should be discussed based on the locally available raw material and concentration of the market outsourcing, so that the group industry targets can be achieved.
- g) The officials organizing the awareness camp has to maintain an attendance register and separate register for recording problems raised in the camp and clarification provided by them. The Minutes of the said camp along with list of persons attended the camp be furnished to the State Director and Dy. CEO of the Zone.
- h) Local cultural programme may be arranged wherever possible.
- i) The State Director has to furnish feedback about the number of projects received by the Banks as a result of such camp in the Village also needs to be furnished to Director (REGP/PMEGP). If any assistance is provided as a follow up action to the said camp also needs to be prominently mentioned in the feed back report.
- j) To be ensure that KVIC/KVIB/DIC banner is prominently displayed at the venue of the camp.
- k) A standard power point presentation CDs both in Hindi and English languages will be prepared with voiceover by the Directorate of PMEGP and sufficient number of CDs will be provided to each KVIC, KVIB and DIC offices for making presentation at District Level Awareness Camps. If needed, same can be translated into regional languages by the respective offices and the expenditure may be met out of Backward & Forward Linkages fund provided to their respective offices.

FINANCIAL PATTERN :

1	<i>Printing of Pamphlets on PMEGP</i>	<i>Rs.5000</i>
2	<i>Local Advertisement</i>	<i>Rs5000</i>
3	<i>Conveyance</i>	<i>Rs.1000</i>
4	<i>Tea/Snacks</i>	<i>Rs.3000</i>
5	<i>Contingency</i>	<i>Rs.1000</i>
6	<i>Hiring hall/Sound System</i>	<i>Rs.4500</i>
7	<i>Hiring of Laptop and projector for presentation</i>	<i>Rs. 500</i>
	Total	Rs.20,000

Interchange of expenditure from one head to another is permitted within overall allocation.

STATE LEVEL WORKSHOP ON PMEGP

These workshops are to be arranged jointly by KVIC/KVIB/DIC in the State.

1 Participants

- i) State Government functionaries preferably Secretary/Joint Secretary of Institutional Finance
- ii) Secretary/Joint Secretary of Industries Department
- iii) State Level functionaries of SSI/DRDA
- iv) The Convener of SLBC
- v) Regional/Zonal Managers/LDMS of public Sector Banks
- vi) Chairman of RRBs
- vii) General Manager of the RBI
- viii) Managing Director of the Private Commercial Bank approved by the State Task Force Committee for implementation of PMEGP in the state
- ix) Chairmen of Co operative Banks approved by State Task Force Committee for implementation of PMEGP in the State
- x) Officials of the NABARD and SIDBI
- xi) KVI Officials
- xii) Chairman and CEO/managing Director/Secretary/Executive Officer and other officials of the State KVI Board.
- xiii) NGOs in the State
- xiv) General Managers of DICs.
- xv) DVIO's
- xvi) PMEGP beneficiaries.

2. Duration of the Workshop

4 to 6 hours.

3. Topics to be covered

- (a) The KVIC official has to explain about KVIC, its aims and objectives, its functions and commitment in the rural and urban areas, the role of KVIB/DICs, the role of the KVIC in rural industrialization in detail , the significant achievement of KVIC and then make a presentation, preferably through power point about the details of the Scheme and its operation procedure.
- (b) To make aware about different circulars instructions issued on the Scheme by KVIC to the participants, if necessary by providing them copies of thereof. Material/Computer floppy on Scheme's presentation through Power Point may either be prepared in the Local language or English/Hindi version of the Scheme may be collected from the Central Office to have uniformity of presentation through out the country.

However, wherever necessary modification may be made to suite the local requirement.

- k) After initial introduction as above, the KVIC/KVIB/DIC officials has to throw open the subject matter for open house discussion, where he has to give required clarification on the points raised or has to solve the problems faced by the PMEGP entrepreneurs.
- l) The KVIC/KVIB/DIC official has to introduce a successful entrepreneur in the camp to share his experience with others.
- m) They should open a discussion on locally available raw material based Industries and on other potential industries in the area.
- n) GroupWise industry targets already communicated should be discussed based on the locally available raw material and concentration of the market outsourcing, so that the group industry targets can be achieved.
- O) It should be ensured that KVIC/KVIB/DIC banner is prominently displayed at the venue of the camp.

Note

After the State Level Workshop is conducted, the minutes of the said workshop along with attendance sheet and photographs of the workshop is to be submitted to the Director (REGP/PMEGP) without fail. Non receipt of such report may result in stoppage of further sanction of funds. In each workshop KVIC's PMEGPs banner may be prominently displayed.

FINANCIAL PATTERN FOR WORKSHOP

1	Hiring Halls, Chairs etc	Rs.50,000/-
2	Hiring of Sound System	Rs10,000/-
3	Printing and Stationary	Rs..50,000/-
4	Tea/Snacks	Rs. 10,000/-
5	Banners/displays	Rs. 10,000/-
6	Misc Expn.	Rs.2000/-
7	Conveyance	Rs. 8000/-
8	Local Advertisement	Rs.60,000/-
	Total	Rs.2,00,000/-

Interchange of expenditure from one head to another is permitted within overall allocation.

STATE LEVEL ORIENTATION WORKSHOP FOR STAFF TRAINING:

Since the new scheme is being implemented, the field staffs of KVIC, KVIB and DICs are to be trained in implementation procedure of the scheme. They are to be trained in respect of the guidelines of the scheme, operational procedure and other operational activities so that the scheme can be implemented in right prospective. For the purpose, the state level workshops for training of the staff of KVIC, KVIB, DICs and Banks will be conducted. The expenditure of the meeting will be restricted to Rs.20,000/- per meeting. All these workshops will be conducted during the first years of implementation of the Scheme. Funds for the same will be met out of Backward Forward Linkages funds provided to field offices of KVIC.

Quarterly Bankers Review Meeting

(i) Lead Districts Managers Meeting (LDMs)

This will be organized by State/Divisional offices of KVIC jointly with KVIB & DIC. The focus of the meeting will be to inform and aware the Bank officials at LDM level about PMEGP, targets and implementation of the scheme. The KVIC will meet the expenditure for conducting such meeting. The maximum expenditure is restricted to an amount of Rs.25.000/- to meet the relevant expenses.

(ii) Zonal Review meeting

To review and monitor the PMEGP scheme, Zonal Review will be conducted quarterly by KVIC in six zones where Representatives of KVIC, KVIB and DIC will participate in the review. Concerned Bank officials will also be invited. KVIC will restrict the expenditure to a maximum amount of Rs.50,000/- per meeting per zone to meet the relevant expenses..

(iii) Top Level Bankers Meeting

KVIC will organize the Top Level Bankers Meeting on half yearly basis (in June and December) so that proper monitoring can be done at the beginning and end of the financial year. CMDs/Senior Executives of Nationalize Banks, Representatives of Ministry of MSME, State DICs and KVIBs will participate in the national level Bankers Meeting which will be chaired by Chairperson/CEO, KVIC. The meeting will focus on reviewing the targets and will examine the issues related to policy decisions relating to Banks for implementation of PMEGP. The expenditure will be restricted to a maximum of Rs.5.00 lakhs per meeting.

EXHIBITION

To be organized jointly by KVIC/KVIB/DICs.

Financial Pattern :

- Dist. Level Exhibition @ Rs.1.00 Lakhs and at least 10 PMEGP beneficiaries participation
- State Level Exhibition @ Rs.5.00 Lakhs with 25 PMEGP beneficiaries participation
- Zonal Level Exhibition @ Rs.20.00 Lakhs with minimum 50 PMEGP beneficiaries participation.
- National level Exhibition @ Rs.40.00 lakhs with minimum 100 PMEGP beneficiaries participation.

Duration :

Dist. Level Exhibition Minimum 3 days
State Level Exhibition Minimum 7 days
Zonal Level Exhibition Minimum 10 days
National Level Exhibition Minimum 15 days

For each State/Region/UT, budget is being provided to conduct a fix number of exhibitions and within the same budget it is permitted to conduct more number of exhibitions without any additional budget demanded.

S.N.	Head of Expenditure	Dist. Level	State Level	Zonal Level	National Level
1	Pendal	15,000.00	50,000.00	1,00,000.00	5,00,000.00
2	Printing Material	15,000.00	50,000.00	5,00,000.00	8,00,000.00
3	Display Demonstration	35,000.00	2,00,000.00	5,00,000.00	7,00,000.00
4	Advertisement in local Media, Newspaper at the time of Exhibition	25,000.00	1,50,000.00	8,00,000.00	15,00,000.00
5	Misc. Expenditure	10,000.00	50,000.00	1,00,000.00	5,00,000.00
	TOTAL	1,00,000.00	5,00,000.00	20,00,000.00	40,00,000.00

Within the budget, interchange of expenditure from one head to another head is permitted.

FOLLOWING AREAS ARE TO BE COVERED :

- The Exhibition should preferably be inaugurated through the Hon'ble Minister, Industry Secretary, Development Commissioner or any other similar dignitaries.
- All State Government Organizations/NGOs/Officials of the state KVI Boards/DIC's and Banks may be invited for Exhibition.
- An arrangement should be made for demonstration of PMEGP products and its sale in the Exhibition.
- The buyers-sellers meet may also be arranged at the place of Exhibition.

- Half-day discussion should be organized and necessary guidance should be provided on quality control, package and design development. The participants should also discuss on technical upgradation, skill development and technical interface.
- Participants may be induced to participate in outside State Exhibitions and outside State beneficiaries may be invited for such exhibition and their views and experience in the production/marketing may be shared with other participants of the State.
- Availability of raw material in outside State at cheaper/reasonable rate for various products may be ascertained and made available to the participants and their interaction may be arranged wherever necessary through the interpreter to overcome the problem of language. Wherever possible technical expert or marketing expert may be invited to guide the participants in removing the bottlenecks of marketing.
- Other technical expert personalities such as designers, packagers, printers, federations and marketing experts etc. may also be called for to participate in the discussion to share their views and stress the importance of the subject matters to the participants from sales promotions point of view.
- Co-sponsorship for the exhibition may be arranged through local banks, NGOs, NABARD or any other Social Organisation devoted for Rural Development.
- Detailed report on exhibition alongwith photographs of the event may be sent to Director (REGP/PMEGP).

PROMOTIONAL ACTIVITIES

Under Promotional Activities of PMEGP, following areas are to covered :

1. Hording/Banners at important places.
2. Publishing posters on PMEGP.
3. Workshops for KVIB/DIC/Employment Exchange Officers/Gram Pradhans/Panchayats be conducted and insist their active participation in each Workshop and Awareness Camp.
4. Publicity in Electronic and Print Media.
5. Printing of Village Industries directory with beneficiaries details.
6. For all the above activities in each advertisement KVIC name, PMEGP Scheme and Ministry of MSME be compulsory displayed and while sending the reports/photos, the clippings of such advertisement bearing KVIC, PMEGP Scheme and Ministry name be sent to Directorate of REGP/PMEGP in the absence of which no further funds be released.

PRINTING OF APPLICATIONS ON PMEGP :

KVIC/KVIB/DIC offices will arrange for printing of applications, Marin money Claim format, EDP Training format as per colour code i.e. Projects being forwarded to Task Force by KVIC will be in white colour, through KVIB in yellow colour and through DICs in sky blue colour. All the application forms, returns etc. related to beneficiaries is to be printed in respective colour for proper documentation. The expenditure for the same should be met out of B/F Linkages fund being provided to them.

FORMAT FOR SPONSORING THE BENEFICIARY FOR UNDERGOING EDP TRAINING

ATTESTED PHOTO
OF THE BENEFICIARY

1	Name and Address of the beneficiary		
2	Name of the Activity		
3	Location of the Unit		
4	Whether the beneficiary belongs to SC/ST/OBC/Minority/Ex. Servicemen/ PHC/Women OR General		
5	Name of Financing Bank with Add		
6	Total Cost of the Project	C.E.	W.C.
7	Amount sanctioned with date		
8	If the beneficiary is Institution, Trust, Co.op Society, Name & Designation of the Representative	Name _____	Designation _____

I hereby sponsor Shri/Smt/Kum _____ undergoing EDP training at your Training Institute.

Signature of the Branch Manager
(With Seal)

Place :

Date :

To,

1) The Principal,

2)

The State/Divisional Director
KVIC _____ for kind information

.....
(Certificate to be issued by Training Centre)

Shri/Smt/Kum _____ sponsored by the above said Bank has undergone 2 weeks EDP Training from _____ to _____ kindly send the recoupmnt of the expenditure of Rs. _____ at the earliest.

Signature of the Principal/Incharge
of the Training Centre

Place :

Date :

To,

The State Director,
Khadi and V.I. Commission,

To,

The Divisional Director,
Khadi and V.I. Commission

Copy to : The Branch Manger (Financing Branch)

PUBLICITY AND PROMOTIONAL CAMPAIGN FOR PRIME MINISTER'S EMPLOYMENT GENERATION PROGRAMME (PMEGP)

I. OBJECTIVE :

To promote and publicize the Scheme of PMEGP among the target audience, i.e., rural artisans and unemployed persons in rural areas as well as bankers, policy makers and related organizations working for rural development.

Utilization of effective medias of mass communication like Print Media including press advertisements, leaflets, posters, etc., Electronic Media including Radio and TV, Out-door Media, i.e., Hoarding, Awareness Camps, etc.

II. ACTION PLAN :

To achieve the above objective, it is proposed to go in for the following activities through the field offices of KVIC as well as centralized campaign from the Central Office :

I) ADVERTISEMENT CAMPAIGN :

A) Print Media :

The Print Media includes the following :

- a) Newspapers
- b) Magazines
- c) Posters, leaflets, etc.

It is proposed to go in for announcement advertisement of half page on PMEGP in leading newspapers of English, Hindi and vernacular newspapers, State-wise, announcing the launching of PMEGP Scheme alongwith its salient features at DAVP rate. This will be followed by advertisements and press features on PMEGP based on the local circulation figures and their reach in rural areas for promoting the scheme. Advertisement will be released on special occasions and events like

- Independence Day,
- Republic Day,
- Mahatma Gandhi Jayanti,
- Holi,
- Consumers Day,
- Environment Day, Women's Day etc...

and events like National Exhibitions, Seminars at Vigyan Bhavan, Ashoka Hall, etc. Similarly, advertorials will be published in leading magazines like India Today, Outlook, Frontline, In-flight magazines like Namaskar, Darpan, Swagat, other magazines like Women's Era, Saritha, Grihalakshmi and regional magazines like Malayala Manorama, etc. Leaflets and posters will be printed for promoting PMEGP Scheme which could be displayed in various KVIC/KVIB offices, Banks and distributed in events like Awareness Camps, Workshops, Exhibitions, Seminars, etc. and also in form of mailers in newspapers and clip mail.

B. Electronic Media :

The Electronic advertisement will consist of the following :

- i) Radio jingles
- ii) TV Advertisement spots
- iii) TV Strips
- iv) Sponsoring Programmes like Question- answer on PMEGP.
- v) Interviews of Chairperson, CEO, etc.
- vi) TV Serial on PMEGP.
- vii) Short film on PMEGP taking in success stories of REGP and projecting the future potential of PMEGP and its benefit for rural India.
- viii) Advertisement on Internet in various sites like Yahoo, google, redifmail, msn.com, etc. **DAVP rates will be insisted on all electronic and print media advertisements.**

C. Out-door Publicity :

Out-door Publicity will be through following methods :

- i) Hoardings at Airports, Railway Stations, Bus-stands, etc.
- ii) Flex banners
- iii) Translites
- iv) Bus panels
- v) Train panels
- vi) Advertisement on train tickets

The hoardings will be put up before Collectrate Office, Bus-stands, Block Panchayats and Railway Stations or Panchayat Office at District level for promoting the scheme of PMEGP. Hoardings will also be put up in all Airports of all State Capitals. The hoardings will be installed locally by the concerned State/Divisional Directors of KVIC/KVIB/DICs. The creative will focus on PMEGP Scheme and invite unemployed artisans and rural people to avail the benefit of the Scheme which shall be prepared with the help of professional advertising agencies.

III. PRESS CONFERENCE AND PRESS PUBLICITY:

Adequate coverage will be given for promoting PMEGP in the form of features and articles. For this purpose, regular press interaction, press meets and press conferences will be organized coinciding with events, achievements, etc. A professional in the area of press liaison and media relations will be engaged on contract basis for this purpose.

IV. PRINTING OF PUBLICATIONS, LITERATURES, ETC.:

It is proposed to bring out following literature/publications for promoting PMEGP :-

- i) 200 project profiles for benefit of potential beneficiaries.
- ii) Leaflet in English and Hindi and local vernacular language on PMEGP and its salient features.
- iii) A Hand Book on PMEGP and its operational modalities for the benefit of KVIC and KVIB field offices and banks.
- iv) A Book on Success Stories on REGP Units which could be a motivating factor for potential PMEGP beneficiaries.

V. SETTING UP OF PMEGP WEBSITE :

REGP/PMEGP Website has already been designed and is in the process of finalization. The site will feature all relevant circulars, policy guidelines as well as data base of REGP Units and their products. This will also feature new events, policy circulars, details of major achievements, progress report, etc.

VI. AWARENESS CAMPS/PEOPLE'S EDUCATION PROGRAMME

:

For promoting PMEGP Scheme effectively in rural areas, it is proposed to organize awareness campaigns at district-level by involving following agencies :

- i) Panchayat Raj Institutions.
- ii) Nehru Yuva Kendra.
- iii) Women Development Organizations.
- iv) State-level SC/ST and Minority Development Organizations.
- v) Rajiv Gandhi Udyami Mitras
- vi) Banks.
- vii) KVI institutions.

The focus of the campaign will be to orient rural youth including women with focus on SC/ST and Minorities on PMEGP and motivating them to avail the benefit of the Scheme for self-employment. It is proposed to have atleast one campaign in each district, i.e., 603 campaigns per year which can be organized by KVIC, KVIB or a reputed NGO including Khadi Institution. Banks will also be involved to brief about the Scheme and monitor the proposals received out of such campaigns. A detailed list of the potential beneficiaries will be maintained by the concerned State/Divisional Office of KVIC and application forms will be distributed to collect the data of the potential beneficiary and through details of the project he/she is interested to set up. Screening will be done by local Committee of the applications so received and the screened applicants can be provided training/skill development through nearby MDTC or accredited centers after which they shall be provided the support in project formulation and then project will be submitted to banks for sanction. The Banker will also be involved in the local Committee so as to ensure sanction of viable projects under PMEGP.

Funds available with the Directorate of Publicity, KVIC, Mumbai and with the State Governments under Publicity head may also be utilised for the purpose of promoting PMEGP scheme.